



RS300-E7 / RS4

1U Rackmount Server

User Guide



E7411

First Edition

May 2012

Copyright © 2012 ASUSTeK COMPUTER INC. All Rights Reserved.

No part of this manual, including the products and software described in it, may be reproduced, transmitted, transcribed, stored in a retrieval system, or translated into any language in any form or by any means, except documentation kept by the purchaser for backup purposes, without the express written permission of ASUSTeK COMPUTER INC. ("ASUS").

ASUS provides this manual "as is" without warranty of any kind, either express or implied, including but not limited to the implied warranties or conditions of merchantability or fitness for a particular purpose. In no event shall ASUS, its directors, officers, employees, or agents be liable for any indirect, special, incidental, or consequential damages (including damages for loss of profits, loss of business, loss of use or data, interruption of business and the like), even if ASUS has been advised of the possibility of such damages arising from any defect or error in this manual or product.

Specifications and information contained in this manual are furnished for informational use only, and are subject to change at any time without notice, and should not be construed as a commitment by ASUS. ASUS assumes no responsibility or liability for any errors or inaccuracies that may appear in this manual, including the products and software described in it.

Product warranty or service will not be extended if: (1) the product is repaired, modified or altered, unless such repair, modification or alteration is authorized in writing by ASUS; or (2) the serial number of the product is defaced or missing.

Products and corporate names appearing in this manual may or may not be registered trademarks or copyrights of their respective companies, and are used only for identification or explanation and to the owners' benefit, without intent to infringe.

Contents

Notices.....	vii
Safety information	viii
About this guide	ix

Chapter 1: Product introduction

1.1	System package contents	1-2
1.2	Serial number label	1-2
1.3	System specifications	1-3
1.4	Front panel features.....	1-5
1.5	Rear panel features.....	1-5
1.6	Internal features	1-6
1.7	LED information	1-7
1.7.1	Front panel LEDs	1-7
1.7.2	LAN (RJ-45) LEDs	1-8
1.7.3	HDD status LED.....	1-8

Chapter 2: Hardware setup

2.1	Chassis cover.....	2-2
2.2	Central Processing Unit (CPU)	2-3
2.2.1	Installing the CPU	2-3
2.2.2	Installing the CPU heatsink and airduct.....	2-6
2.3	System memory	2-8
2.3.1	Overview	2-8
2.3.2	Memory Configurations.....	2-8
2.3.3	Installing a DIMM	2-9
2.3.4	Removing a DIMM	2-9
2.4	Hard disk drives	2-10
2.5	Expansion slot.....	2-12
2.5.1	Installing an expansion card to the riser card bracket... 2-12	
2.5.2	Configuring an expansion card	2-14
2.6	Cable connections	2-15
2.7	SATA/SAS backplane cabling	2-16
2.8	Removable/optional components.....	2-17
2.8.1	System fans	2-17
2.8.2	Installing ASUS PIKE RAID card (optional)	2-18
2.8.3	Installing ASMB5 series management board (optional) 2-20	

Contents

Chapter 3: Installation options

3.1 Friction Rail Kit Installation Guide	3-2
3.1.1 Attaching the fixing latches to the server	3-2
3.2 Installing optional ball-bearing rail kit items	3-5
3.2.1 Attaching the rails to the server	3-5
3.2.2 Attaching the rack rails.....	3-6
3.2.3 Mounting the server to the rack	3-7

Chapter 4: Motherboard Info

4.1 Motherboard layout	4-2
4.2 Jumpers	4-4
4.3 Internal connectors	4-9
4.4 Internal LEDs	4-18

Chapter 5: BIOS setup

5.1 Managing and updating your BIOS	5-2
5.1.1 ASUS CrashFree BIOS 3 utility	5-2
5.1.2 ASUS EZ Flash Utility	5-3
5.1.3 BUPDATER utility.....	5-4
5.2 BIOS setup program	5-6
5.2.1 BIOS menu screen.....	5-7
5.2.2 Menu bar.....	5-7
5.2.3 Menu items	5-8
5.2.4 Submenu items	5-8
5.2.5 Navigation keys.....	5-8
5.2.6 General help	5-8
5.2.7 Configuration fields	5-8
5.2.8 Pop-up window	5-8
5.2.9 Scroll bar.....	5-8
5.3 Main menu	5-9
5.3.1 System Date	5-9
5.3.2 System Time	5-9
5.3.3 Security	5-9
5.4 Event Logs menu	5-11
5.5 Advanced menu	5-13
5.5.1 ACPI Settings.....	5-13

Contents

5.5.2	Trusted Computing.....	5-14
5.5.3	WHEA Configuration	5-14
5.5.4	CPU Configuration	5-15
5.5.5	North Bridge	5-17
5.5.6	South Bridge	5-17
5.5.7	SATA Configuration	5-18
5.5.8	Intel TXT(LT) Configuration.....	5-19
5.5.9	USB Configuration	5-19
5.5.10	ME Subsystem	5-20
5.5.11	Onboard Devices Configuration	5-20
5.5.12	APM	5-22
5.5.13	Serial Port Console Redirection.....	5-23
5.5.14	Network Stack.....	5-24
5.6	Monitor menu	5-25
5.7	Boot menu	5-26
5.8	Tool menu	5-28
5.9	Exit menu	5-28
 Chapter 6: RAID configuration		
6.1	Setting up RAID.....	6-2
6.1.1	RAID definitions	6-2
6.1.2	Installing hard disk drives.....	6-2
6.1.3	RAID controller selection	6-3
6.1.4	Setting the RAID item in BIOS	6-3
6.2	LSI Software RAID Configuration Utility	6-4
6.2.1	Creating a RAID set	6-5
6.2.2	Adding or viewing a RAID configuration	6-11
6.2.3	Initializing the virtual drives	6-12
6.2.4	Rebuilding failed drives.....	6-16
6.2.5	Checking the drives for data consistency	6-18
6.2.6	Deleting a RAID configuration.....	6-21
6.2.7	Selecting the boot drive from a RAID set.....	6-22
6.2.8	Enabling WriteCache	6-23
6.3	Intel® Rapid Storage Technology Option ROM Utility.....	6-24
6.3.1	Creating a RAID set	6-25

Contents

- 6.3.2 Creating a Recovery set 6-26
- 6.3.3 Deleting a RAID set 6-28
- 6.3.4 Resetting disks to Non-RAID 6-29
- 6.3.5 Recovery Volume Options 6-30
- 6.3.6 Exiting the Intel® Rapid Storage Technology utility..... 6-31
- 6.3.7 Rebuilding the RAID 6-31
- 6.3.8 Setting the Boot array in the BIOS Setup Utility..... 6-33

Chapter 7: Driver installation

- 7.1 RAID driver installation 7-2**
 - 7.1.1 Creating a RAID driver disk 7-2
 - 7.1.2 Installing the RAID controller driver 7-5
- 7.2 Intel® chipset device software installation..... 7-13**
- 7.3 LAN driver installation..... 7-15**
- 7.4 VGA driver installation..... 7-18**
- 7.5 Management applications and utilities installation 7-21**
 - 7.5.1 Running the support DVD 7-21
 - 7.5.2 Drivers menu..... 7-21
 - 7.5.3 Utilities menu 7-22
 - 7.5.4 Make disk menu..... 7-22
 - 7.5.5 Contact information..... 7-22
- ASUS contact information A-1**

Notices

Federal Communications Commission Statement

This device complies with Part 15 of the FCC Rules. Operation is subject to the following two conditions:

- This device may not cause harmful interference, and
- This device must accept any interference received including interference that may cause undesired operation.

This equipment has been tested and found to comply with the limits for a Class B digital device, pursuant to Part 15 of the FCC Rules. These limits are designed to provide reasonable protection against harmful interference in a residential installation. This equipment generates, uses and can radiate radio frequency energy and, if not installed and used in accordance with manufacturer's instructions, may cause harmful interference to radio communications. However, there is no guarantee that interference will not occur in a particular installation. If this equipment does cause harmful interference to radio or television reception, which can be determined by turning the equipment off and on, the user is encouraged to try to correct the interference by one or more of the following measures:

- Reorient or relocate the receiving antenna.
- Increase the separation between the equipment and receiver.
- Connect the equipment to an outlet on a circuit different from that to which the receiver is connected.
- Consult the dealer or an experienced radio/TV technician for help.



WARNING! The use of shielded cables for connection of the monitor to the graphics card is required to assure compliance with FCC regulations. Changes or modifications to this unit not expressly approved by the party responsible for compliance could void the user's authority to operate this equipment.

Canadian Department of Communications Statement

This digital apparatus does not exceed the Class A limits for radio noise emissions from digital apparatus set out in the Radio Interference Regulations of the Canadian Department of Communications.

This Class A digital apparatus complies with Canadian ICES-003.



DO NOT throw the motherboard in municipal waste. This product has been designed to enable proper reuse of parts and recycling. This symbol of the crossed out wheeled bin indicates that the product (electrical and electronic equipment) should not be placed in municipal waste. Check local regulations for disposal of electronic products.



DO NOT throw the mercury-containing button cell battery in municipal waste. This symbol of the crossed out wheeled bin indicates that the battery should not be placed in municipal waste.

Safety information

Electrical Safety

- Before installing or removing signal cables, ensure that the power cables for the system unit and all attached devices are unplugged.
- To prevent electrical shock hazard, disconnect the power cable from the electrical outlet before relocating the system.
- When adding or removing any additional devices to or from the system, ensure that the power cables for the devices are unplugged before the signal cables are connected. If possible, disconnect all power cables from the existing system before you add a device.
- If the power supply is broken, do not try to fix it by yourself. Contact a qualified service technician or your dealer.

Operation Safety

- Any mechanical operation on this server must be conducted by certified or experienced engineers.
- Before operating the server, carefully read all the manuals included with the server package.
- Before using the server, ensure all cables are correctly connected and the power cables are not damaged. If any damage is detected, contact your dealer as soon as possible.
- To avoid short circuits, keep paper clips, screws, and staples away from connectors, slots, sockets and circuitry.
- Avoid dust, humidity, and temperature extremes. Place the server on a stable surface.



This product is equipped with a three-wire power cable and plug for the user's safety. Use the power cable with a properly grounded electrical outlet to avoid electrical shock.

Lithium-Ion Battery Warning

CAUTION! Danger of explosion if battery is incorrectly replaced. Replace only with the same or equivalent type recommended by the manufacturer. Dispose of used batteries according to the manufacturer's instructions.

CD-ROM Drive Safety Warning

CLASS 1 LASER PRODUCT

Heavy System

CAUTION! This server system is heavy. Ask for assistance when moving or carrying the system.

About this guide

Audience

This user guide is intended for system integrators, and experienced users with at least basic knowledge of configuring a server.

Contents

This guide contains the following parts:

1. **Chapter 1: Product introduction**

This chapter describes the general features of the server, including sections on front panel and rear panel specifications.

2. **Chapter 2: Hardware setup**

This chapter lists the hardware setup procedures that you have to perform when installing or removing system components.

3. **Chapter 3: Installation options**

This chapter describes how to install optional components into the barebone server.

4. **Chapter 4: Motherboard information**

This chapter gives information about the motherboard that comes with the server. This chapter includes the motherboard layout, jumper settings, and connector locations.

5. **Chapter 5: BIOS information**

This chapter tells how to change system settings through the BIOS Setup menus and describes the BIOS parameters.

6. **Chapter 6: RAID configuration**

This chapter tells how to change system settings through the BIOS Setup menus. Detailed descriptions of the BIOS parameters are also provided.

7. **Chapter 7: Driver installation**

This chapter provides instructions for installing the necessary drivers for different system components.

Conventions

To ensure that you perform certain tasks properly, take note of the following symbols used throughout this manual.



DANGER/WARNING: Information to prevent injury to yourself when trying to complete a task.



CAUTION: Information to prevent damage to the components when trying to complete a task.



IMPORTANT: Instructions that you **MUST** follow to complete a task.



NOTE: Tips and additional information to help you complete a task.

Typography

Bold text

Indicates a menu or an item to select.

Italics

Used to emphasize a word or a phrase.

<Key>

Keys enclosed in the less-than and greater-than sign means that you must press the enclosed key.

Example: <Enter> means that you must press the Enter or Return key.

<Key1+Key2+Key3>

If you must press two or more keys simultaneously, the key names are linked with a plus sign (+).

Example: <Ctrl+Alt+Del>

Command

Means that you must type the command exactly as shown, then supply the required item or value enclosed in brackets.

Example: At the DOS prompt, type the command line: **format A:/S**

References

Refer to the following sources for additional information, and for product and software updates.

1. **ASUS Server Web-based Management (ASWM) user guide**

This manual tells how to set up and use the proprietary ASUS server management utility.

2. **ASUS websites**

The ASUS websites worldwide provide updated information for all ASUS hardware and software products. Refer to the ASUS contact information.

Chapter 1

This chapter describes the general features of the chassis kit. It includes sections on front panel and rear panel specifications.

Product introduction

1.1 System package contents

Check your system package for the following items.

Model Name	RS300-E7/RS4
Chassis	ASUS P10E 1U Rackmount Chassis
Motherboard	ASUS P8B-E/4L Server Board
Component	1 x 450W Redundant Power Supply 4 x Hot-swap 3.5" HDD trays 1 x SAS/SATA Backplane (BP4LX-R10A) 1 x PCI Riser Card (RE16LE8R-R10A) 1 x Front I/O Board (FPB-AR14) 4 x System Fans (40mm x 28mm)
Accessories	1 x RS300-E7/RS4 Series User's Guide 1 x ASUS ASWM Enterprise User's Guide 1 x RS300-E7/RS4 Series Support DVD 1 x ASWM Enterprise DVD 1 x Bag of Screws 2 x AC Power Cable 1 x Fix Rail Kit
Optional Items	CPU Heatsink ASUS ASMB5-iKVM Remote management card Slim-type Optical Device Second 450W Redundant Power Supply Module

*ASUS System Web-based Management



If any of the above items is damaged or missing, contact your retailer.

1.2 Serial number label

Before requesting support from the ASUS Technical Support team, you must take note of the product's serial number containing 14 characters such as xxS0xxxxxxxxxx shown as the figure below. With the correct serial number of the product, ASUS Technical Support team members can then offer a quicker and satisfying solution to your problems.



1.3 System specifications

The ASUS RS300-E7/RS4 Series is a 1U barebone server system featuring the ASUS P8B-E/4L server board. The server supports Intel® LGA1155 Sandy Bridge and Ivy Bridge processors, plus other latest technologies through the chipsets onboard.

Model Name		RS300-E7/RS4
Processor / System Bus		1 x Socket LGA1155
		<ul style="list-style-type: none"> - Intel® Xeon® E3-1200 v2 Processor Family - Intel® Xeon® E3-1200 Processor Family - Intel® Core™ i3-2100 Processor Family - Intel® Pentium™ G8X0 / G6X0 - Intel® Celeron™ G5X0 / G4X0
Core Logic		Intel® C204 chipset
ASUS Features	Smart Fan	√
	ASWM2.0	√
Memory	Total Slots	4 (2 Channels)
	Capacity	Maximum up to 32GB
	Memory Type	DDR3 1066 / 1333 / 1600 *ECC UDIMM *DDR3 1600 can only be supported with Intel® Xeon® E3-1200 v2 Processor Family
	Memory Size	1GB, 2GB, 4GB and 8GB
Expansion Slots	Total PCI/PCI-X/PCI-E Slots	2
	Slot Type	1 x PCI-E x16 (Gen3* / Gen2 x8 link) (Full-Height/HL) 1 x PCI-E x8 (Gen3* / Gen2 x8 link) (Full-Height/HL) *Gen3 link can only be supported with Intel® Xeon® E3-1200 v2 Processor
	Additional Slot 1	1 x PIKE slot for storage enhancement
Storage	SATA Controller	Intel® C204: 2 x SATA 6Gb/s ports 2 x SATA 3Gb/s ports Intel Rapid Storage Technology (for Windows only) <ul style="list-style-type: none"> - Supports software RAID 0, 1, 10 & 5 LSI® MegaRAID (for Linux / Windows) <ul style="list-style-type: none"> - Supports software RAID 0, 1 & 10
	SAS Controller	Optional: <ul style="list-style-type: none"> - ASUS PIKE 2008 8-port SAS2 6G RAID card - ASUS PIKE 2008/IMR 8-port SAS2 6G RAID card - ASUS PIKE 2108 8-port SAS2 6G H/W RAID card
HDD Bays	I = internal A or S = hot-swappable	4 x Hot-swap 3.5" HDD Bays

(continued on the next page)

Model Name		RS300-E7/RS4
Networking	LAN	4 x Intel 82574L + 1 x Mgmt LAN
Graphic	VGA	Aspeed AST2050 16MB
Auxiliary Storage Device Bay (Floppy / Optical Device)		1 x Slim-type optical Device Bay Options: No Device / DVD-RW
Onboard I/O		1 x External Serial Port 5 x RJ-45 ports (1 for ASMB5-iKVM) 4 x USB 2.0 ports (Front x 2, Rear x 2) 1 x VGA port 1 x PS/2 keyboard port 1 x PS/2 mouse port
OS Support		Windows® Server 2008 R2 Windows® Server 2008 Enterprise 32/64-bit Windows® Server 2003 R2 Enterprise 32/64-bit RedHat® Enterprise Linux AS5.5/6.0 32/64-bit SuSE® Linux Enterprise Server 10 SP3/11 32/64-bit (Subject to change without any notice)
Management Solution	Out of Band Remote Hardware	Optional ASMB5-iKVM for KVM-over-IP support
	Software	ASUS ASWM Enterprise
Dimension (HH x WW x DD)		615mm x 444mm x 43.4mm
Net Weight Kg (CPU, DRAM & HDD not included)		16 Kg
Power Supply		1+1 Redundant 450W (80+) Gold Power Supply
Power Rating		Input: 100—127/200—240 Vac, 8/4A, 47—63Hz Class1
Environment		Operation temperature: 10°C—35°C / Non operation temperature: -40°C—70°C Non operation humidity: 20%—90% (Non-condensing)

*Specifications are subject to change without notice.

1.4 Front panel features

The barebone server displays a simple yet stylish front panel with easily accessible features. The power and reset buttons, LED indicators, and USB port for each Node are located on the front panel.



Refer to section 1.7.1 **Front panel LEDs** for the LED descriptions.

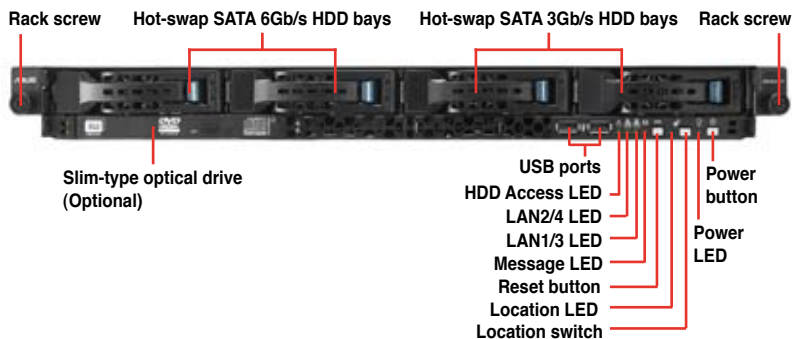

Turn off the system power and detach the power supply before removing or replacing any system component.

1.5 Rear panel features

The rear panel includes the expansion slots, system power sockets, and rear fans. The I/O shields with openings for the rear panel connectors on the motherboard are also placed in the rear panel.



The ports for the USB, VGA, and Gigabit LANs do not appear on the rear panel if the motherboards are not present.

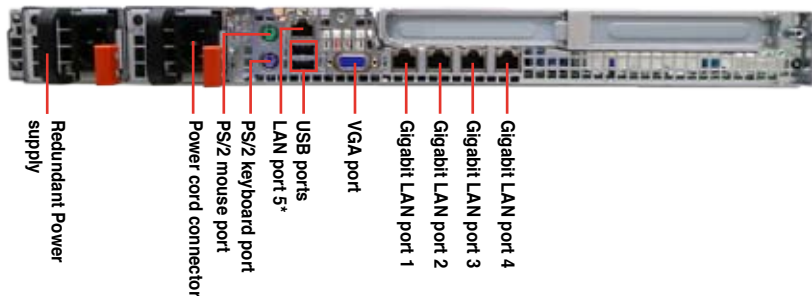

* This port is for ASUS ASMB5-iKVM controller card only.

1.6 Internal features

The barebone server includes the basic components as shown.

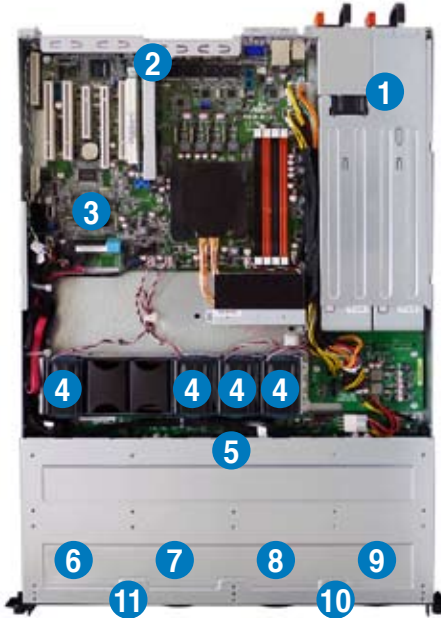

1. Power supply and power fan
2. PCI Express slot Riser Card
3. ASUS P8B-E/4L server boards
4. System fans
5. SAS / SATA backplane (hidden)
6. HDD tray 1—Connect to SATA1 port (SATA 6Gb/s)
7. HDD tray 2—Connect to SATA2 port (SATA 6Gb/s)
8. HDD tray 3—Connect to SATA3 port
9. HDD tray 4—Connect to SATA4 port
10. Front I/O boards (hidden)
11. Slim-type optical drive



Turn off the system power and detach the power supply before removing or replacing any system component.



The barebone server does not include a floppy disk drive. Connect a USB floppy disk drive to any of the USB ports on the front or rear panel if you need to use a floppy disk.

***WARNING**
HAZARDOUS MOVING PARTS
KEEP FINGERS AND OTHER BODY PARTS AWAY

1.7 LED information

1.7.1 Front panel LEDs

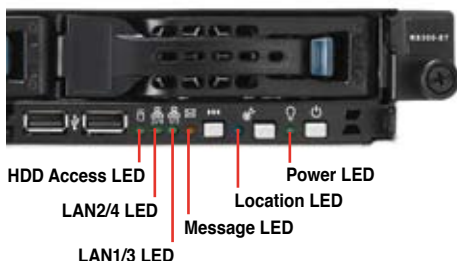

LED	Icon	Display status	Description
Power LED		ON	System power ON
HDD Access LED		OFF	No activity
		Blinking	Read/write data into the HDD
Message LED		OFF	System is normal; no incoming event
		ON	1. Without ASMB5-iKVM installed: CPU over-heated 2. With ASMB5-iKVM installed: a hardware monitor event is indicated
Location LED		OFF	Normal status
		ON	Location switch is pressed (Press the location switch again to turn off)
LAN LEDs		OFF	No LAN connection
		Blinking	LAN is transmitting or receiving data
		ON	LAN connection is present

1.7.2 LAN (RJ-45) LEDs



ACT/LINK LED		SPEED LED	
Status	Description	Status	Description
OFF	No link	OFF	10 Mbps connection
GREEN	Linked	ORANGE	100 Mbps connection
BLINKING	Data activity	GREEN	1 Gbps connection

1.7.3 HDD status LED

HDD status LED



SATA HDD LED	Description
GREEN	This installed Serial ATA HDD is in good condition
OFF	HDD failure or no HDD is installed

Chapter 2

This chapter lists the hardware setup procedures that you have to perform when installing or removing system components.

Hardware setup

2.1 Chassis cover

Removing the rear cover

1. Locate and remove the front side screws.

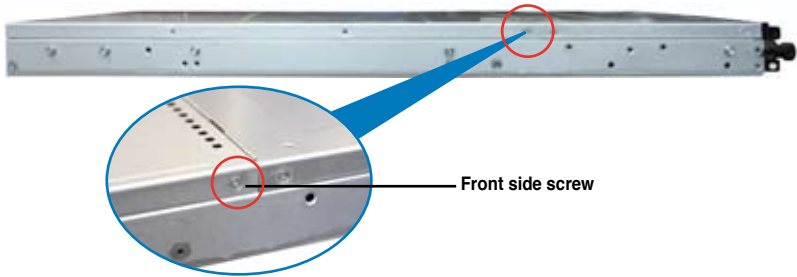

2. Loosen the two thumbscrews on the rear panel to release the rear cover from the chassis.

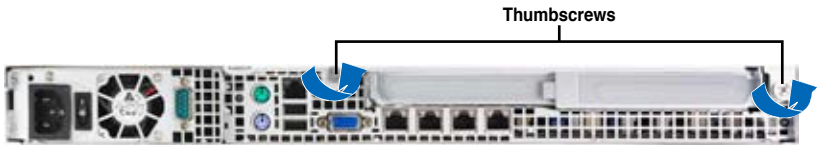

3. Firmly hold the cover and slide it toward the rear panel for about half an inch until it is disengaged from the chassis.
4. Lift the cover from the chassis.
5. To recover the rear cover, reverse step 1 to 4.

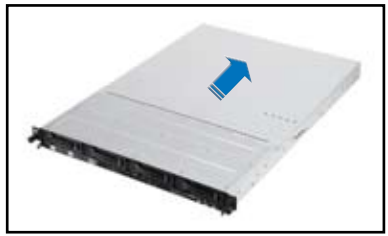

A protection film is pre-attached to the system cover before shipping. Please remove the protection film before turning on the system for proper heat dissipation.



2.2 Central Processing Unit (CPU)

The motherboard comes with a surface mount LGA 1155 Socket designed for the Intel® Sandy Bridge and Ivy Bridge series processors.



Ensure that all power cables are unplugged before installing the CPU.



- Upon purchase of the motherboard, ensure that the PnP cap is on the socket and the socket contacts are not bent. Contact your retailer immediately if the PnP cap is missing, or if you see any damage to the PnP cap/socket contacts/motherboard components. ASUS shoulders the repair cost only if the damage is shipment/transit-related.
- Keep the cap after installing the motherboard. ASUS will process Return Merchandise Authorization (RMA) requests only if the motherboard comes with the cap on the LGA1155 socket.
- The product warranty does not cover damage to the socket contacts resulting from incorrect CPU installation/removal, or misplacement/loss/incorrect removal of the PnP cap.

2.2.1 Installing the CPU

To install a CPU

1. Locate the CPU socket on the motherboard.

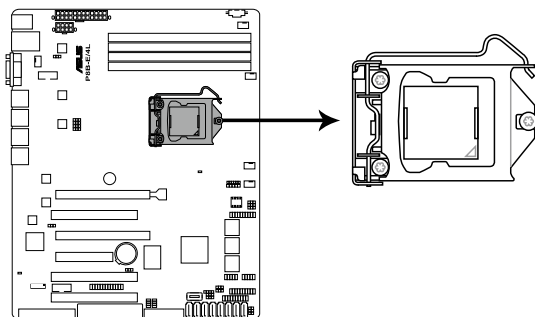

P8B-E/4L CPU LGA1155

2. Press the load lever with your thumb (A), and then move it to the right (B) until it is released from the retention tab.



To prevent damage to the socket pins, do not remove the PnP cap unless you are installing a CPU.

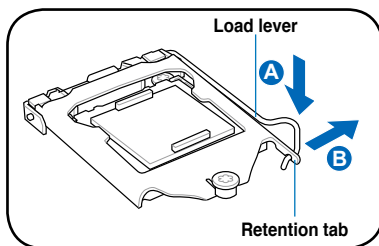

3. Lift the load lever in the direction of the arrow until the load plate is completely lifted.

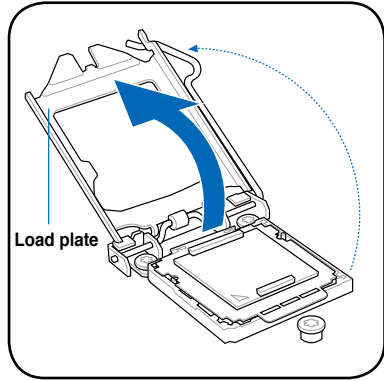

4. Remove the PnP cap from the CPU socket by lifting the tab only.

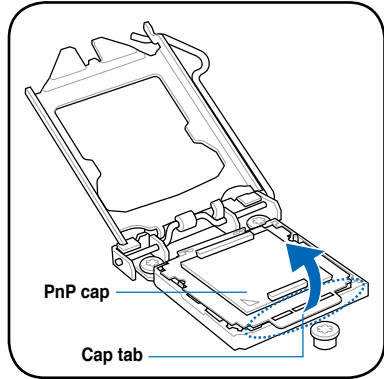

5. Position the CPU over the socket, ensuring that the gold triangle is on the bottom-left corner of the socket, and then fit the socket alignment keys into the CPU notches.



The CPU fits in only one correct orientation. **DO NOT** force the CPU into the socket to prevent bending the connectors on the socket and damaging the CPU!

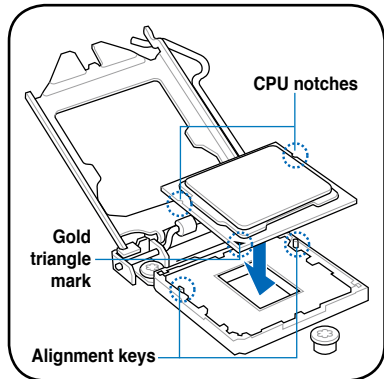

6. Apply some Thermal Interface Material to the exposed area of the CPU that the heatsink will be in contact with, ensuring that it is spread in an even thin layer.



Some heatsinks come with pre-applied thermal paste. If so, skip this step.



The Thermal Interface Material is toxic and inedible. DO NOT eat it. If it gets into your eyes or touches your skin, wash it off immediately, and seek professional medical help.

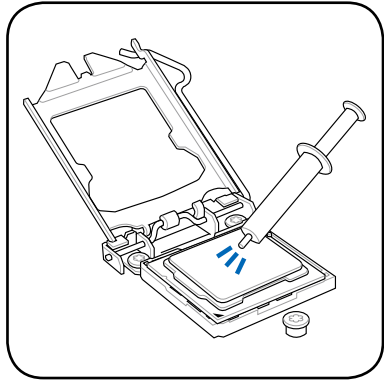

7. Close the load plate (A), and then push down the load lever (B), ensuring that the front edge of the load plate slides under the retention lock (C).

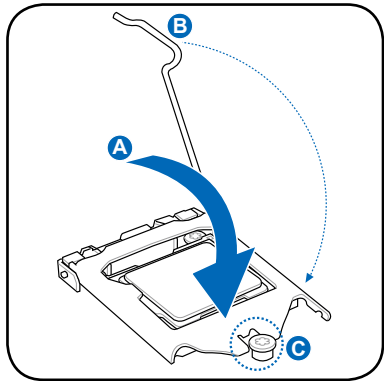

8. Insert the load lever under the retention tab.

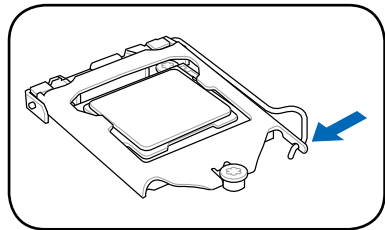

2.2.2 Installing the CPU heatsink and airduct

To install the CPU heatsink

1. Remove the protection sticker on the back of the CPU heatsink.

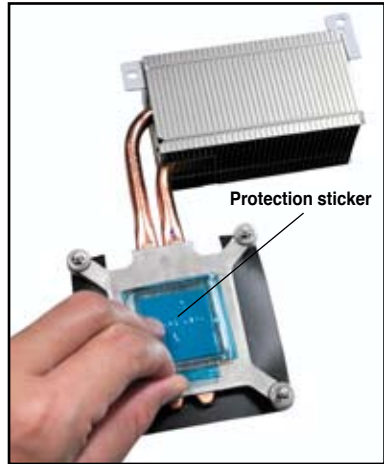

2. Place the heatsink on top of the installed CPU, ensuring that the four fasteners match the holes on the motherboard.

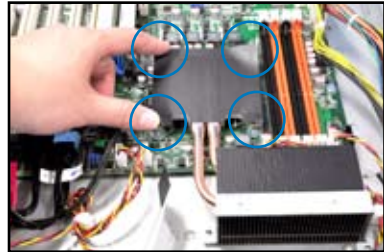

3. Twist each of the four screws with a Philips (cross) screwdriver just enough to attach the heatsink to the motherboard. When the four screws are attached, tighten them one by one to completely secure the heatsink.

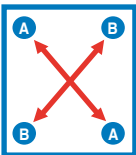
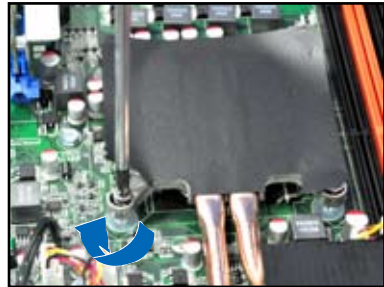

- Tighten the four heatsink screws in a diagonal sequence.
- Do not remove the mylar on the heatsink.

4. Secure the heat pipe and air duct to the server with two screws.

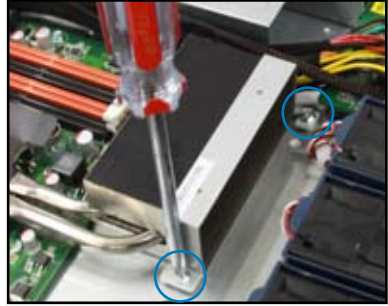

5. Insert the two tips of the system fan mylar into the CPU heatsink, as shown in the right figure.

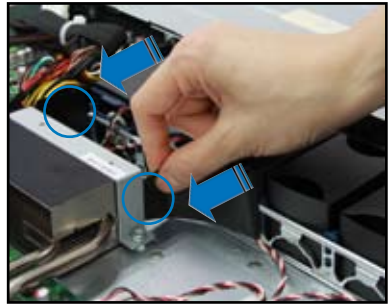

2.3 System memory

2.3.1 Overview

The motherboard comes with six (6) Double Data Rate 3 (DDR3) Dual Inline Memory Modules (DIMM) sockets.

The figure illustrates the location of the DDR3 DIMM sockets:

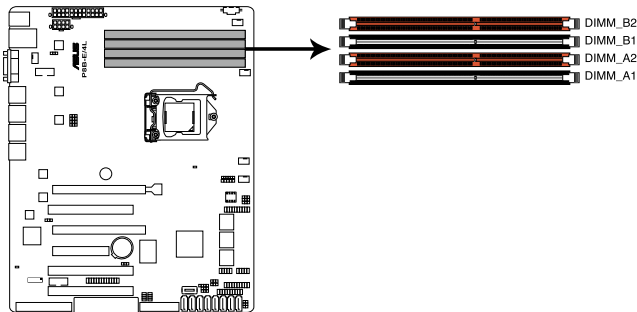

P8B-E/4L 240-pin DDR3 DIMM sockets

2.3.2 Memory Configurations

You may install 1GB, 2GB, 4GB and 8GB Unbuffered with ECC DDR3 DIMMs into the DIMM sockets using the memory configurations in this section.

UDIMM				
DIMM Slot Per Channel	DIMM Populated per Channel	DIMM Type	Speed	Rank per DIMM
2	1	Unbuffered DDR3 ECC	1066/1333/1600*	Single Rank, Dual Rank
2	2	Unbuffered DDR3 ECC	1066/1333/1600*	Single Rank, Dual Rank



- Start installing the DIMMs from slot A2 and B2 (orange).
- Always install DIMMs with the same CAS latency. For optimum compatibility, it is recommended that you obtain memory modules from the same vendor.
- DDR3 1600 can be supported with Intel® Xeon® E3-1200 v2 Processor.

2.3.3 Installing a DIMM



Ensure to unplug the power supply before adding or removing DIMMs or other system components. Failure to do so may cause severe damage to both the motherboard and the components.

1. Unlock a DIMM socket by pressing the retaining clips outward.
2. Align a DIMM on the socket such that the notch on the DIMM matches the DIMM slot key on the socket.

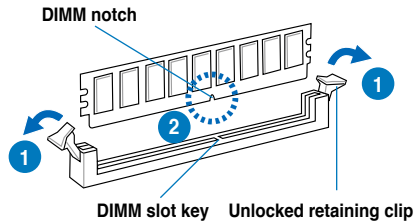

A DIMM is keyed with a notch so that it fits in only one direction. **DO NOT** force a DIMM into a socket in the wrong direction to avoid damaging the DIMM.

3. Hold the DIMM by both of its ends, then insert the DIMM vertically into the socket. Apply force to both ends of the DIMM simultaneously until the retaining clips snap back into place, and the DIMM cannot be pushed in any further to ensure proper sitting of the DIMM.

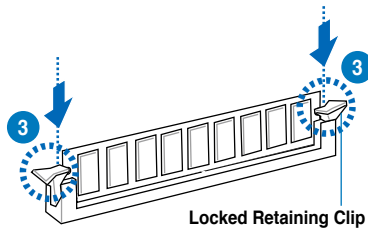

Always insert the DIMM into the socket **VERTICALLY** to prevent DIMM notch damage.

2.3.4 Removing a DIMM

1. Simultaneously press the retaining clips outward to unlock the DIMM.
2. Remove the DIMM from the socket.

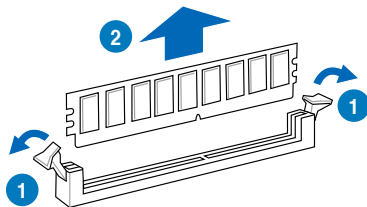

Support the DIMM lightly with your fingers when pressing the retaining clips. The DIMM might get damaged when it flips out with extra force.

2.4 Hard disk drives

The system supports four hot-swap SATAII/SAS hard disk drives and two SATAIII hard disk drives*. The hard disk drive installed on the drive tray connects to the motherboard SATA/SAS ports via the SATA/SAS backplane.



*Install the two SATAIII hard disk drives to HDD tray 1 and 2. Refer to page 1-6 for details.

To install a hot-swap SATA/SAS HDD

1. Release a drive tray by pushing the spring lock to the right, then pulling the tray lever outward. The drive tray ejects slightly after you pull out the lever.

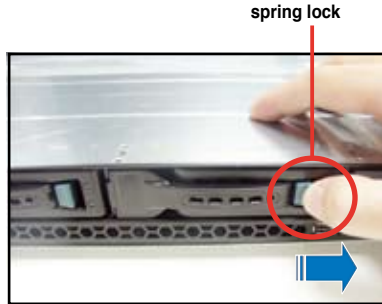

2. Firmly hold the tray lever and pull the drive tray out of the bay.



3. Take note of the drive tray holes. Each side has three holes to fit different types of hard disk drives. Use two screws on each side to secure the hard disk drive.



4. Place a SATA/SAS hard disk drive on the tray, then secure it with four screws.



5. Carefully insert the drive tray and push it all the way to the depth of the bay until just a small fraction of the tray edge protrudes.



When installed, the SATA/SAS connector on the drive connects to the SATA/SAS interface on the backplane.

6. Push the tray lever until it clicks, and secures the drive tray in place. The drive tray is correctly placed when its front edge aligns with the bay edge.
7. Repeat steps 1 to 6 if you wish to install a second SATA/SAS drive.



2.5 Expansion slot

2.5.1 Installing an expansion card to the riser card bracket

The barebone server comes with a riser card bracket. You need to remove the bracket if you want to install PCI Express x8 or x16 expansion cards.

To install a PCI Express x8 or x16 card:

1. Firmly hold the riser card bracket, then pull it up to detach it from the PCI Express x16 slot on the motherboard.

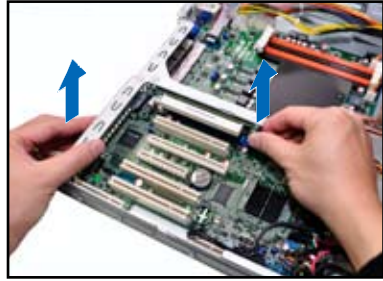

2. Place the riser card bracket on a flat and stable surface, then remove the screw from the slot bay.

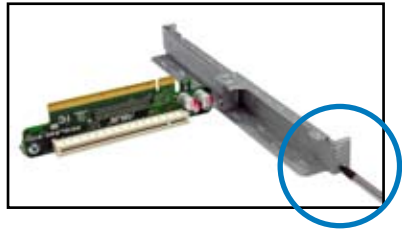

3. Install a PCI Express x8 or x16 card to the bracket as shown, then secure the card with a screw.

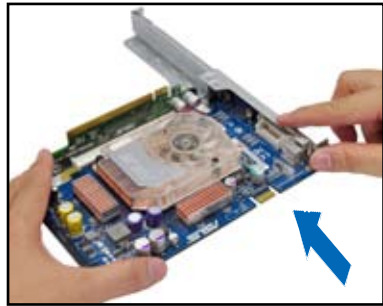

4. Repeat the previous steps to Install another PCI Express x8 or x16 card if needed.

To reinstall the riser card bracket:

1. Align the riser card bracket with the cards to the PCI Express x16 slot on the motherboard.
2. Press the riser card bracket until the golden connectors completely fit the slot and the bracket aligns with the rear panel.
3. Connect the cable(s) to the card, if applicable.

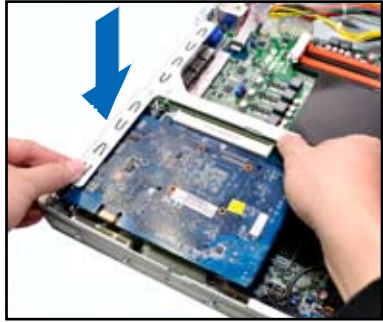

2.5.2 Configuring an expansion card

After installing the expansion card, configure the it by adjusting the software settings.

1. Turn on the system and change the necessary BIOS settings, if any. See Chapter 5 for information on BIOS setup.
2. Assign an IRQ to the card. Refer to the following tables.
3. Install the software drivers for the expansion card.

Standard Interrupt assignments

IRQ	Priority	Standard function
0	1	System Timer
1	2	Keyboard Controller
2	-	Programmable Interrupt
3*	11	Communications Port (COM2)
4*	12	Communications Port (COM1)
5*	13	--
6	14	Floppy Disk Controller
7*	15	--
8	3	System CMOS/Real Time Clock
9*	4	ACPI Mode when used
10*	5	IRQ Holder for PCI Steering
11*	6	IRQ Holder for PCI Steering
12*	7	PS/2 Compatible Mouse Port
13	8	Numeric Data Processor
14*	9	Primary IDE Channel
15*	10	Secondary IDE Channel

* These IRQs are usually available for ISA or PCI devices.

2.6 Cable connections



- The bundled system cables are pre-connected before shipment. You do not need to disconnect these cables unless you will remove pre-installed components to install additional devices.
- Refer to Chapter 4 for detailed information on the connectors.

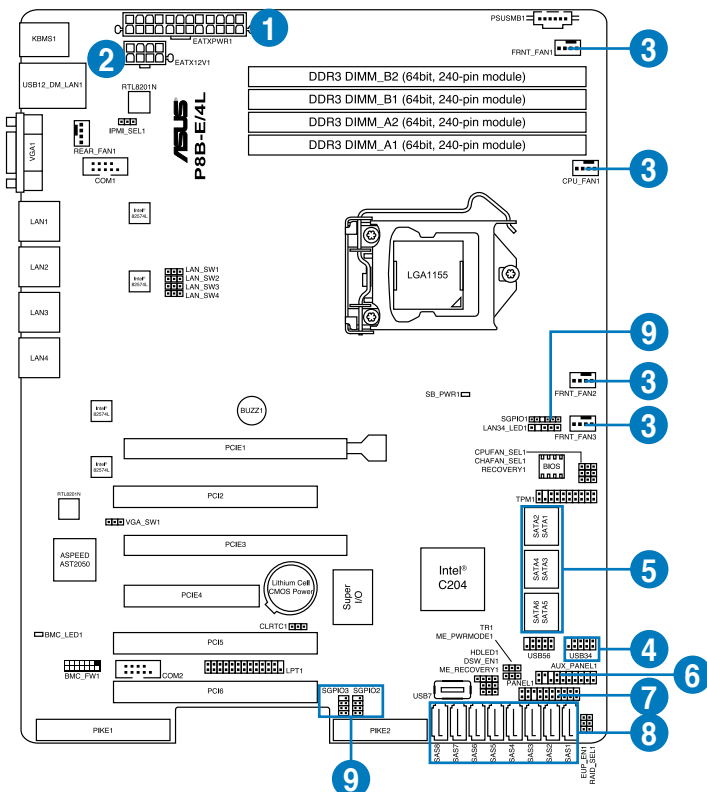

Standard cables connected to the motherboard

1. 24-pin ATX power connector (from power supply to motherboard)
2. 8-pin 12V power connector (from power supply to motherboard)
3. System fan connector (from system fan to motherboard)
4. USB connector (from motherboard to front I/O board)
5. SATA connectors (system default; from motherboard to SATA/SAS backplane)
6. System auxiliary panel connector (from motherboard to front I/O board)
7. System panel connector (from motherboard to front I/O board)
8. SAS connectors (for ASUS PIKE only; from motherboard to SATA/SAS backplane)
9. Serial General Purpose Input/Output connectors
 (SATA: from motherboard SGPIO1 to SATA/SAS backplane J2 connector
 SAS: from motherboard SGPIO2 to SATA/SAS backplane J7 connector
 SAS: from motherboard SGPIO3 to SATA/SAS backplane J6 connector)

2.7 SATA/SAS backplane cabling

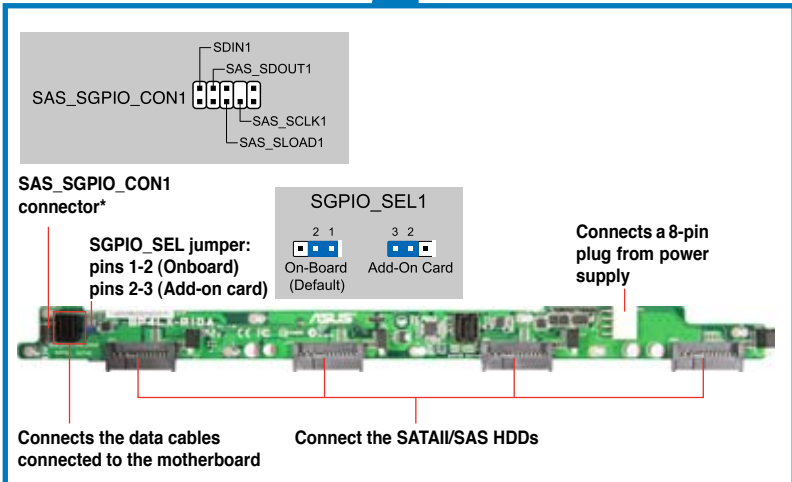

* For PIKE RAID solution, ensure to connect SAS_SGPIO_CON1 to support PIKE card SAS RAID function.

2.8 Removable/optional components

You may need to remove previously installed system components when installing or removing system devices. Or you may need to install the optional components into the system. This section tells how to remove/install the following components:

1. System fans
2. ASUS PIKE RAID card (optional)
3. ASUS ASMB5-iKVM (optional)



Ensure that the system is turned off before removing any components.

2.8.1 System fans

To uninstall the system fans:

1. Disconnect the system fan cable from the fan connector on the motherboard.

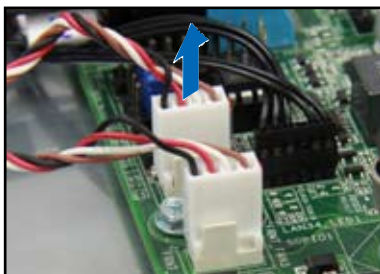

2. Lift the fan, then set aside.
3. Repeat steps 1 to 2 to uninstall the other system fans.

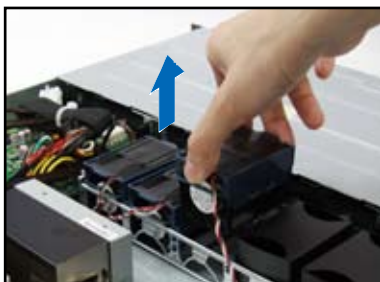

To reinstall the system fans

1. Insert the fan to the fan cage. The airflow directional arrow on the fan side should point towards the system rear panel.
2. Connect the system fan cable to the fan connector on the motherboard.

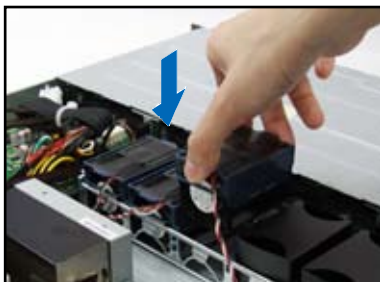

2.8.2 Installing ASUS PIKE RAID card (optional)

Follow the steps below to install an optional ASUS RAID card on your motherboard.

1. Locate the PIKE RAID card slot on the motherboard.

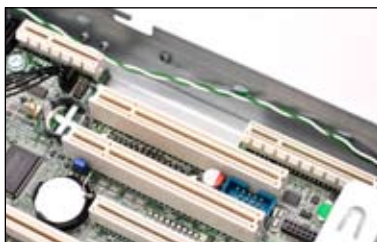

2. Align the golden fingers of the RAID card with the PIKE RAID card slot.

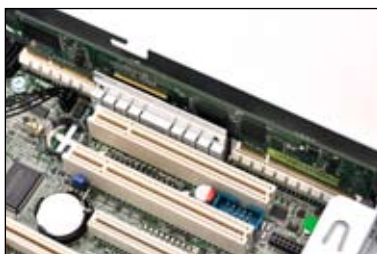

3. Insert the RAID card into the PIKE RAID card slot. Ensure that it is completely seated on the PIKE RAID card slot.

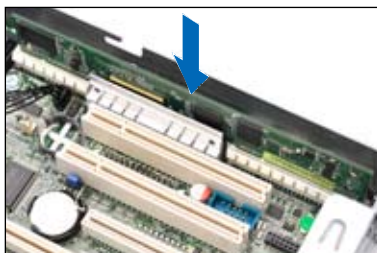

4. Remove the SATA/SAS cables from the onboard SATA1-4 connectors.

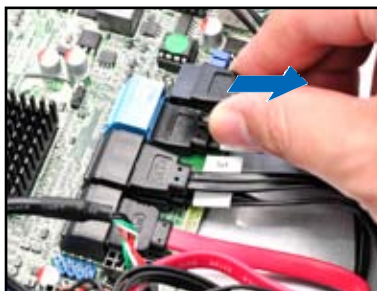

5. Connect the SATA/SAS cables to the onboard SAS1-4 connectors (blue).

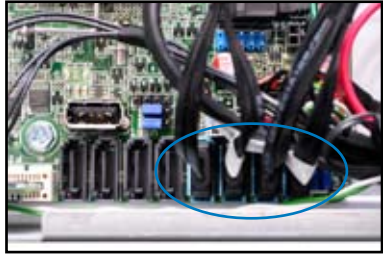

6. Move the **SGPIO_SEL1** jumper on the SATA/SAS backplane to 2-3.



2.8.3 Installing ASMB5 series management board (optional)

Follow the steps below to install an optional ASMB5 series management board on your motherboard.

1. Locate the BMC_FW header on the motherboard.



2. Orient and press the ASMB5 management card in place.

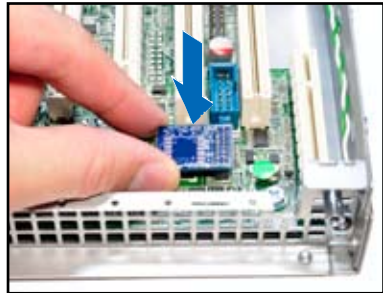

3. Insert the LAN cable plug to the LAN port 5 (dedicated LAN) or LAN port 1 (shared LAN) for server management.



LAN port 5

LAN port 1

Chapter 3

This chapter describes how to install the optional components and devices into the barebone server.

Installation options

3.1 Friction Rail Kit Installation Guide

Your friction rail kit package contains:

- One pair of rack rails
- One pair of fixing latches
- 4 latch screws, 4 rail screws and 4 rail washers

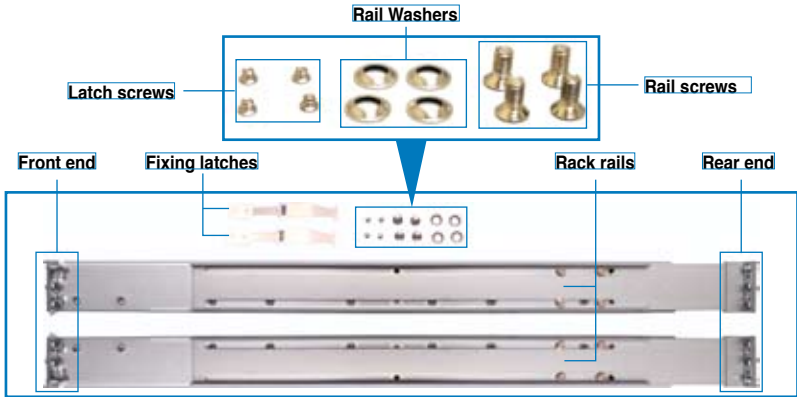

3.1.1 Attaching the fixing latches to the server

1. Secure the two fixing latches to the two sides of the server with the four latch screws.



The locations of the screw holes vary with different server models. Refer to your server user manual for details.

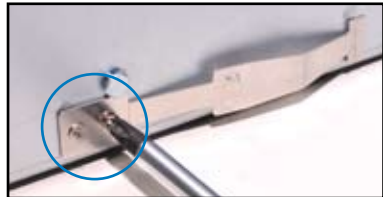

2. Select a 1U space on the rack where you want to install the rack rail. A 1U space consists of three square mounting holes with two thin lips on the top and the bottom, as shown in the right figure.
3. Adjust the rack rail to fit the depth of the rack.

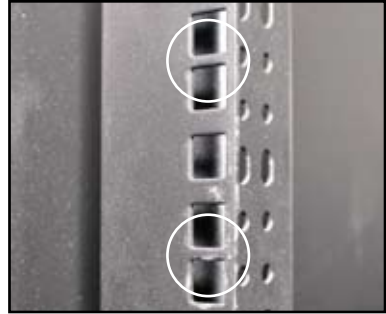

4. From inside the rack, place the rear rail hook on the bottom thin lip of the rear mounting hole, and then place the front rail hook on the bottom thin lip of the front mounting hole, as shown in the right figure.



5. Secure the front and rear ends of the rail with two rack screws and washers.
6. Repeat step 3 to 5 to attach the rack rail on the other side of the rack.



- 7. When mounting the server to the rack, ensure to include the side knots on the two sides of the server in the rack rail holders, as shown in the right figure.

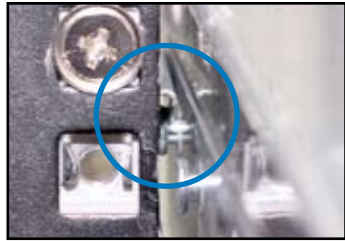

Do not install the rail kit in the following situation:

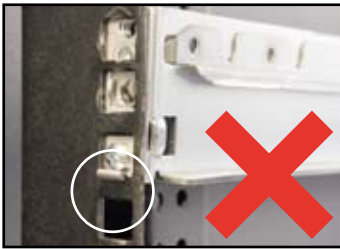

DO NOT place the rail hook on a thick lip of the mounting hole.



DO NOT install the rail to the outer side of the server rack.

3.2 Installing optional ball-bearing rail kit items

Your optional ball-bearing rail kit package contains:

- two pair of server rails (for the server)
- two pairs of rack rails (for the rack)
- Nut-and-bolt type screws

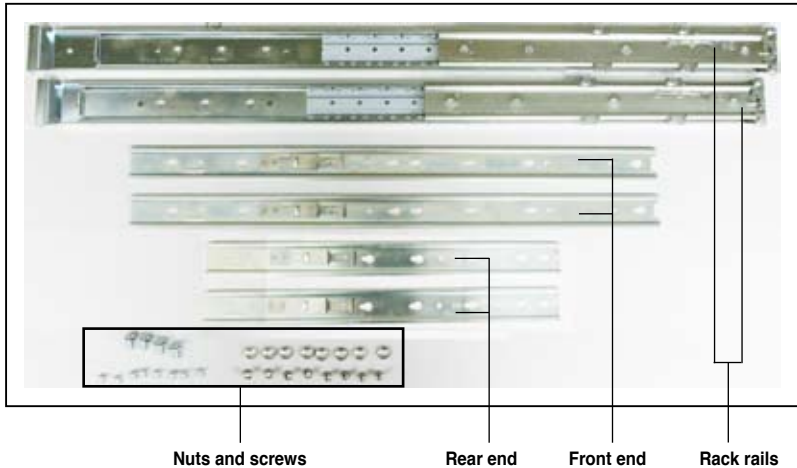

3.2.1 Attaching the rails to the server

To attach the server rails:

1. Attach the front end of the server rail to the side of the chassis, matching each of the three hooks to the holes on the rail. Then slide the rail toward the front panel until it locks in place.
2. Secure the front end of the server rail to the side of the chassis with one screw.

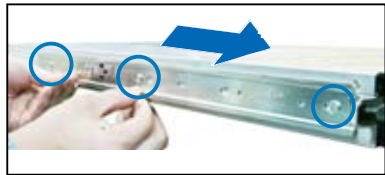

3. Attach the rear end of the server rail to the side of the chassis, matching each of the two hooks to the holes on the rail. Then slide the rail toward the front panel until it locks in place.

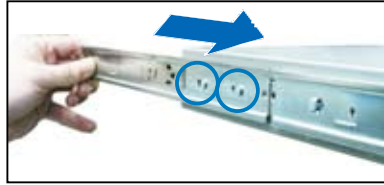

4. Secure the rear end of the server rail to the side of the chassis with one screw.



5. Repeat steps 1 to 4 to attach the second server rail to the other side of the chassis.

3.2.2 Attaching the rack rails

To attach the rack rails:

1. Select one unit of space (1U) on the rack where you want to install the barebone server.
2. Install the nuts on the holes of the 1U space on the rack front.
3. Install the nuts on the holes of the 1U space on the corresponding rack rear.
4. Measure the depth of the rack to determine the length of the rack rails.
5. Measure the rack rail when assembled to ensure that it fits the rack.
6. Position the rack rail to the 1U space on the rack. Ensure that the front end of the rack rail goes to the front of the rack space.
7. Secure the front end of the rail with two rack screws.
8. Secure the rear end of the rail with two rack screws.
9. Repeat steps 5 to 8 to assemble and attach the second rack rail.



3.2.3 Mounting the server to the rack

To mount the server to the rack:

1. Align the server rails with the rack rails, then push the server all the way to the depth of the rack.
2. Tighten the two rack screws to secure the server in place.



To uninstall the server from the rack:

1. Loosen the rack screws that secured the server to the rack.
2. Pull the server from the rack.



Remember to press the latches on both sides to release the server from the rack.

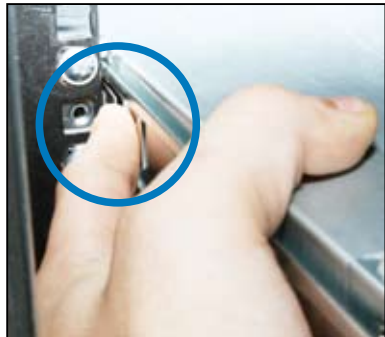

Chapter 4

This chapter includes the motherboard layout and brief descriptions of the jumpers and internal connectors.

Motherboard Info

4.1 Motherboard layout

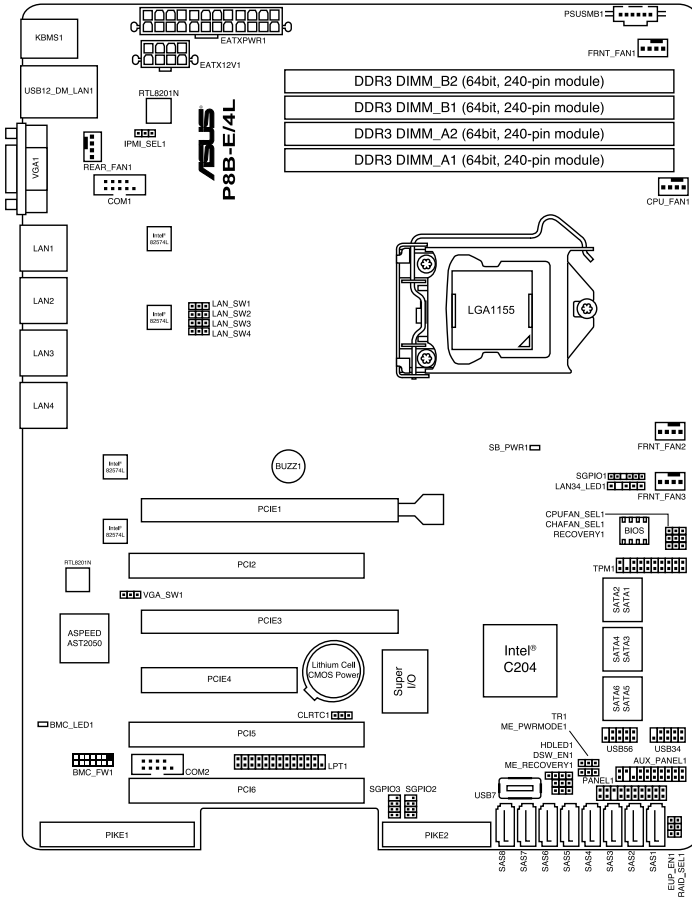

Layout contents

Jumpers		Page
1.	Clear RTC RAM (CLRTC1)	4-4
2.	VGA controller setting (3-pin VGA_SW1)	4-5
3.	CPU Fan and Chassis Fan control setting (3-pin CPUFAN_SEL1, CHAFAN_SEL1)	4-5
4.	LAN controller setting (3-pin LAN_SW1, LAN_SW2, LAN_SW3, LAN_SW4)	4-6
5.	RAID configuration utility selection (3-pin RAID_SEL1)	4-6
6.	Force BIOS recovery setting (3-pin RECOVERY1)	4-7
7.	Chassis intrusion connector (2-pin CHASSIS)	4-8
8.	ME firmware force recovery setting (3-pin ME_RECOVERY1)	4-8

Internal connectors		Page
1.	Serial ATA connectors (SATA 6Gb/s: 7-pin SATA1, SATA2 [Blue]) (SATA 3Gb/s: 7-pin SATA3, SATA4, SATA5, SATA6 [Black])	4-9
2.	SAS connectors (7-pin SAS1, SAS2, SAS3, SAS4 [Blue]) (7-pin SAS5, SAS6, SAS7, SAS8 [Black])	4-10
3.	Hard disk activity LED connector (4-pin HDLED1)	4-10
4.	USB connector (10-1 pin USB34, USB56; A-Type USB7)	4-11
5.	CPU, front and rear fan connectors (4-pin CPU_FAN1, FRNT_FAN1, FRNT_FAN2, FRNT_FAN3, REAR_FAN1)	4-11
6.	Serial General Purpose Input/Output connector (6-1 pin SGPIO1)	4-12
7.	Serial General Purpose Input/Output connectors (8-1 pin SGPIO2/3)	4-12
8.	Serial port connectors (10-1 pin COM1/COM2)	4-13
9.	BMC header (BMC_FW1)	4-13
10.	Power Supply SMBus connector (5-pin PSUSMB1)	4-14
11.	TPM connector (20-1-pin TPM)	4-14
12.	ATX power connectors (24-pin EATXPWR1, 8-pin EATX12V1)	4-15
13.	Parallel port connector (26-1 pin LPT1)	4-15
14.	System panel connector (20-1 pin PANEL1)	4-16
15.	Auxiliary panel connector (20-2 pin AUX_PANEL1)	4-17

Internal connectors		Page
1.	Standby power LED	4-19
15.	BMC LED (BMC_LED1)	4-19

4.2 Jumpers

1. Clear RTC RAM (CLRTC1)

This jumper allows you to clear the Real Time Clock (RTC) RAM in CMOS. You can clear the CMOS memory of date, time, and system setup parameters by erasing the CMOS RTC RAM data. The onboard button cell battery powers the RAM data in CMOS, which include system setup information such as system passwords.

To erase the RTC RAM:

1. Turn OFF the computer and unplug the power cord.
2. Move the jumper cap from pins 1–2 (default) to pins 2–3. Keep the cap on pins 2–3 for about 5–10 seconds, then move the cap back to pins 1–2.
3. Plug the power cord and turn ON the computer.
4. Hold down the key during the boot process and enter BIOS setup to re-enter data.



Except when clearing the RTC RAM, never remove the cap on CLRTC jumper default position. Removing the cap will cause system boot failure!



If the steps above do not help, remove the onboard battery and move the jumper again to clear the CMOS RTC RAM data. After the CMOS clearance, reinstall the battery.

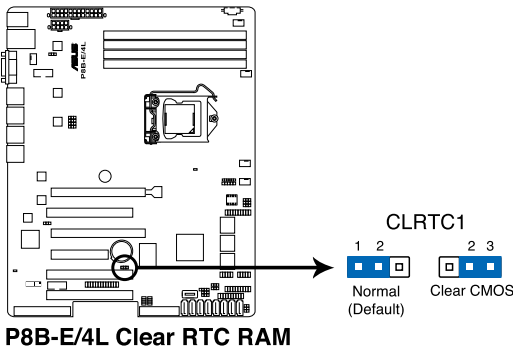

2. VGA controller setting (3-pin VGA_SW1)

This jumper allows you to enable or disable the onboard VGA controller. Set to pins 1–2 to activate the VGA feature.

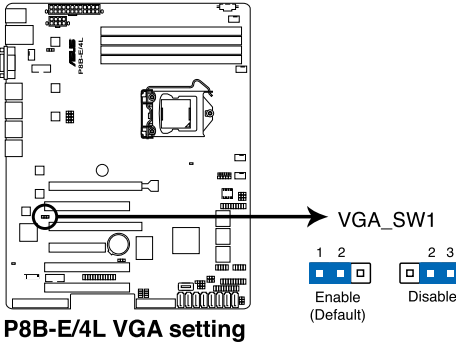

3. CPU Fan and Chassis Fan control setting (3-pin CPUFAN_SEL1, CHAFAN_SEL1)

These jumpers allow you to switch for fan pin selection. The CPUFAN_SEL1 jumper is for the CPU fans control and the CHAFAN_SEL1 jumper is for the front fans and rear fans control. Set to pins 1–2 when using 4-pin fans or pins 2–3 when using 3-pin fans.

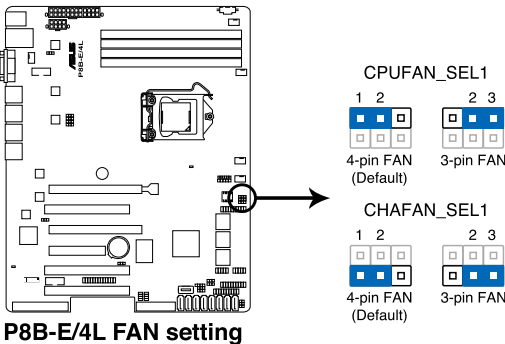

- If you use a 4-pin fan but set the jumper to pin 2–3, the fan you installed may not work.
- If you use a 3-pin fan but set the jumper for a 4-pin fan, the fan control will not work and the fan you installed will always run at full speed.

4. LAN controller setting (3-pin LAN_SW1, LAN_SW2, LAN_SW3, LAN_SW4)

These jumpers allow you to enable or disable the onboard Intel® 82574L Gigabit LAN controllers. Set pins 1-2 to activate the Gigabit LAN feature.

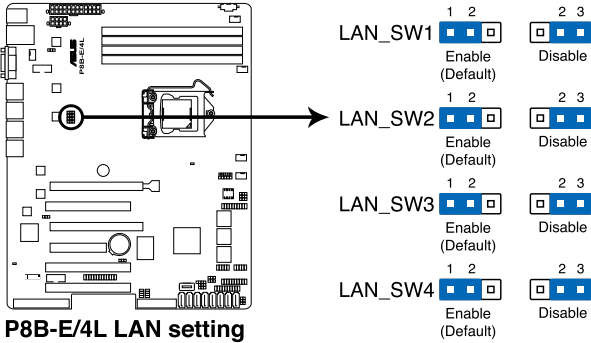

5. RAID configuration utility selection (3-pin RAID_SEL1)

This jumper allows you to select the RAID configuration utility to use when you create disk arrays. Place the jumper caps over pins 1–2 if you want to use the LSI Logic Embedded SATA RAID Setup Utility (default); otherwise, place the jumper caps to pins 2–3 to use the Intel® Rapid Storage Technology.

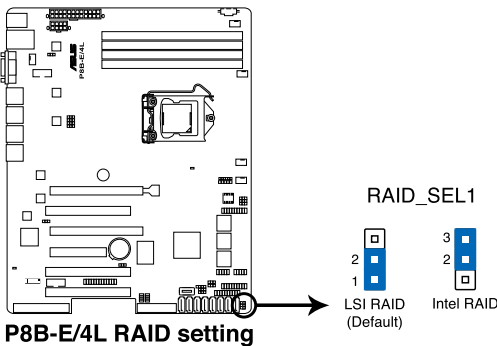

6. Force BIOS recovery setting (3-pin RECOVERY1)

This jumper allows you to quickly update or recover the BIOS settings when it becomes corrupted.

To update the BIOS:

1. Prepare a USB flash disk that contains the original or latest BIOS for the motherboard (XXXXXX.ROM) and the BUPDATER.EXE utility.
2. Set the jumper to pins 2–3.
3. Insert the USB flash and turn on the system to update the BIOS.
4. Shut down the system.
5. Set the jumper back to pins 1–2.
6. Turn on the system.

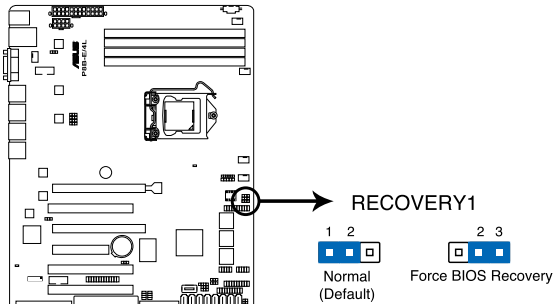

P8B-E/4L force BIOS recovery setting

7. Chassis intrusion connector (2 pin CHASSIS)

This connector is for a chassis-mounted intrusion detection sensor or switch. Connect one end of the chassis intrusion sensor or switch cable to this connector. The chassis intrusion sensor or switch sends a high-level signal to this connector when a chassis component is removed or replaced. The signal is then generated as a chassis intrusion event.

By default , the pin labeled “Chassis Signal” and “Ground” are shorted with a jumper cap. Remove the jumper caps only when you intend to use the chassis intrusion detection feature.

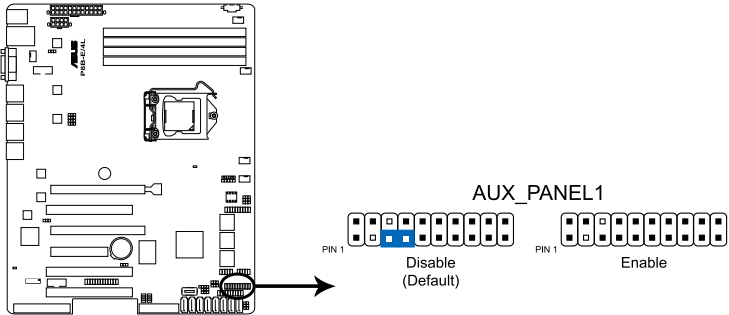

P8B-E/4L Chassis intrusion connector

8. ME firmware force recovery setting (3-pin ME_RECOVERY1)

This jumper allows you to quickly recover the Intel Management Engine (ME) firmware when it becomes corrupted.

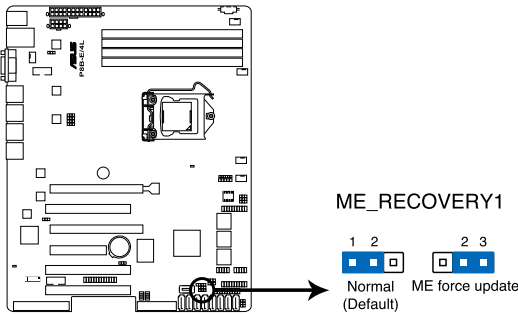

P8B-E/4L ME firmware force recovery setting

4.3 Internal connectors

1. Serial ATA connectors

(SATA 6Gb/s: 7-pin SATA1, SATA2 [Blue])

(SATA 3Gb/s: 7-pin SATA3, SATA4, SATA5, SATA6 [Black])

Supported by the Intel® C204 chipset, these connectors are for the Serial ATA signal cables for Serial ATA hard disk drives that allows up to 6Gb/s of data transfer rate.

If you installed Serial ATA hard disk drives, you can create a RAID 0, RAID 1, RAID 10, or RAID 5 configuration.

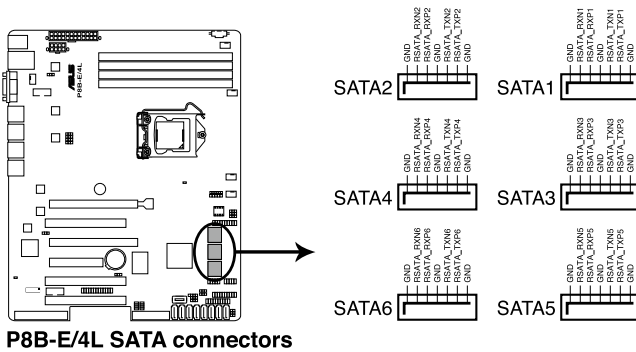

P8B-E/4L SATA connectors



The actual data transfer rate depends on the speed of Serial ATA hard disks installed.

2. SAS connectors
(7-pin SAS1, SAS2, SAS3, SAS4 [Blue])
(7-pin SAS5, SAS6, SAS7, SAS8 [Black])

This motherboard comes with eight (8) Serial Attached SCSI (SAS) connectors, the next-generation storage technology that supports both Serial Attached SCSI (SAS) and Serial ATA (SATA). Each connector supports one device.



- These connectors function only when you install a PIKE RAID card.
- Connect the SAS hard disk drives to SAS connectors 1–4 (blue) when installing a 4-port PIKE RAID card.

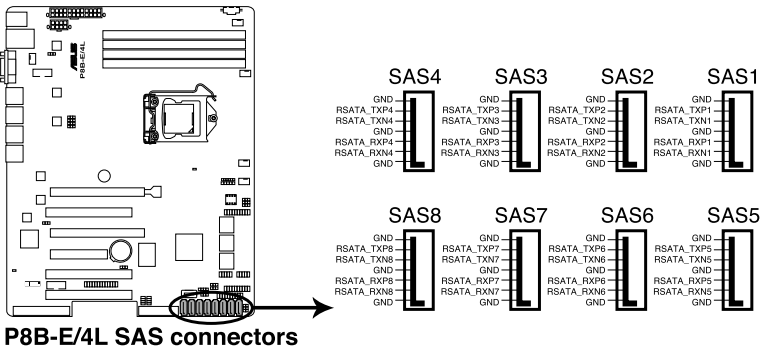

3. Hard disk activity LED connector (4-pin HDLED1)

This LED connector is for the storage add-on card cable connected to the SATA or SAS add-on card. The read or write activities of any device connected to the SATA or SAS add-on card causes the front panel LED to light up.

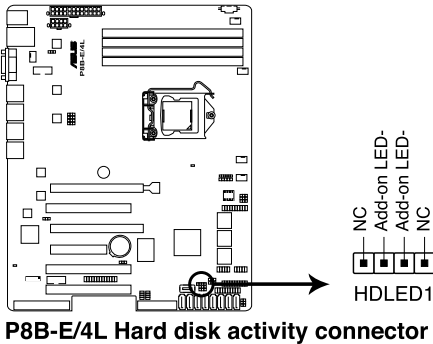

4. USB connector (10-1 pin USB34, USB56; A-Type USB7)

These connectors are for USB 2.0 ports. Connect the USB module cables to connectors USB34 and USB56, then install the modules to a slot opening at the back of the system chassis. These USB connectors comply with USB 2.0 specification that supports up to 480 Mbps connection speed.

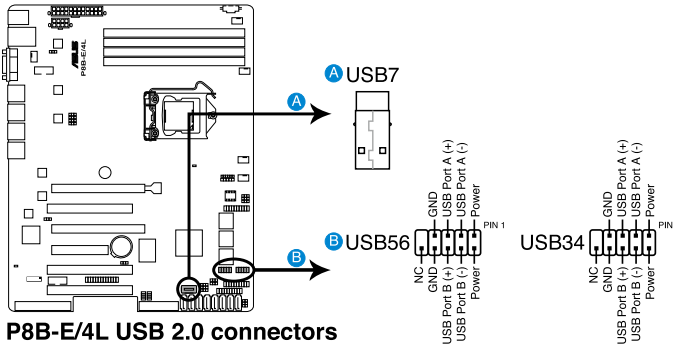

5. CPU, front and rear fan connectors (4-pin CPU_FAN1, FRNT_FAN1, FRNT_FAN2, FRNT_FAN3, REAR_FAN1)

The fan connectors support cooling fans of 350 mA–740 mA (8.88 W max.) or a total of 3.15 A–6.66 A (53.28 W max.) at +12V. Connect the fan cables to the fan connectors on the motherboard, ensuring that the black wire of each cable matches the ground pin of the connector.



- DO NOT forget to connect the fan cables to the fan connectors. Insufficient air flow inside the system may damage the motherboard components.
- These are not jumpers! DO NOT place jumper caps on the fan connectors!
- All fans feature the ASUS Smart Fan technology.

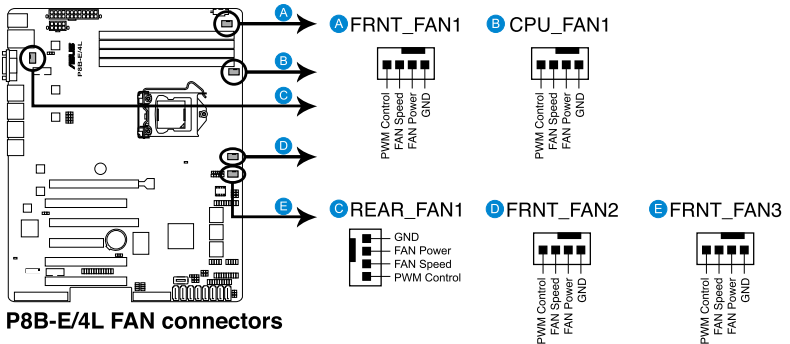

6. Serial General Purpose Input/Output connector (6-1 pin SGPIO1)

This connector is used for the SGPIO peripherals for the Intel Rapid Storage Technology RAID SATA LED.

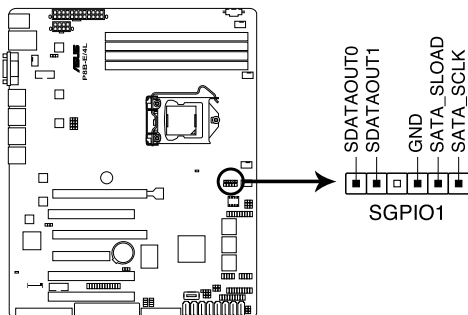

P8B-E/4L SGPIO1 connector

7. Serial General Purpose Input/Output connectors (8-1 pin SGPIO2/3)

These connectors are used for the SAS chip SGPIO interface that controls the LED pattern generation, device information and general purpose data.

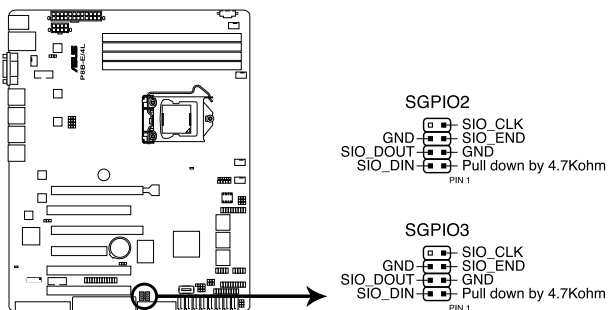

P8B-E/4L SGPIO2/3 connectors



These connectors function only when you install an ASUS PIKE SAS RAID card.

8. Serial port connectors (10-1 pin COM1/COM2)

These connectors are for the serial (COM) ports. Connect the serial port module cable to one of these connectors, then install the module to a slot opening at the back of the system chassis.

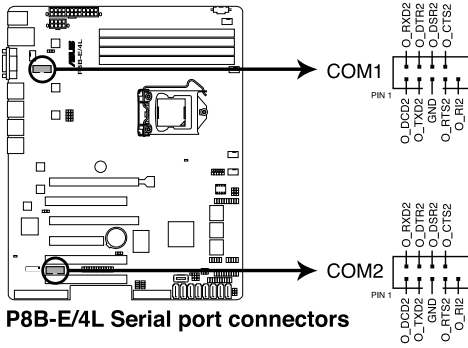

P8B-E/4L Serial port connectors

9. BMC header (BMC_FW1)

The BMC connector on the motherboard supports an ASUS® Server Management Board 5 Series (ASMB5).

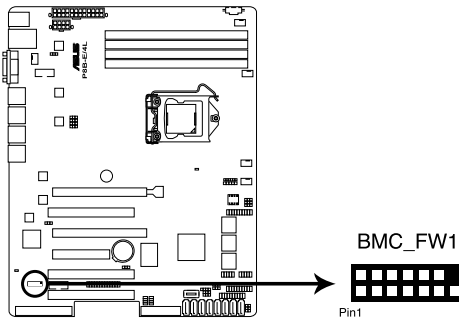

P8B-E/4L BMC connector

10. Power Supply SMBus connector (5-pin PSUSMB1)

This connector allows you to connect SMBus (System Management Bus) to the power supply unit to read PSU information. Devices communicate with an SMBus host and/or other SMBus devices using the SMBus interface.

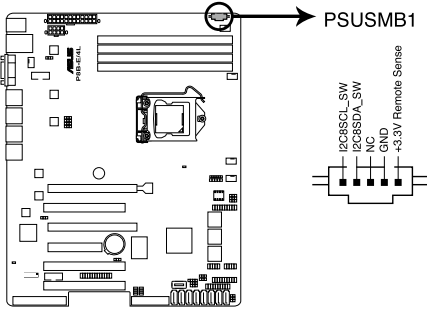

P8B-E/4L Power supply SMBus connector



This connector functions only when you install the ASUS ASMB5.

11. TPM connector (20-pin TPM)

This connector supports a Trusted Platform Module (TPM) system, which can securely store keys, digital certificates, passwords, and data. A TPM system also helps enhance network security, protects digital identities, and ensures platform integrity.

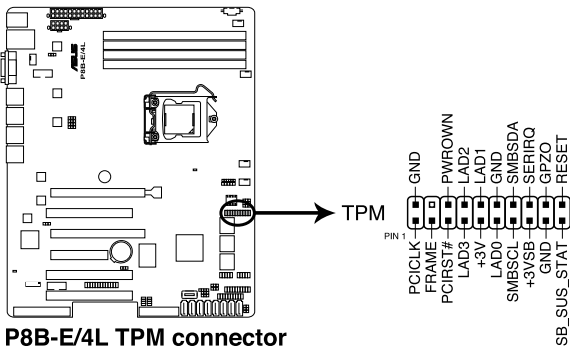

P8B-E/4L TPM connector

12. ATX power connectors (24-pin EATXPWR1, 8-pin EATX12V1)

These connectors are for an ATX power supply plugs. The power supply plugs are designed to fit these connectors in only one orientation. Find the proper orientation and push down firmly until the connectors completely fit.



- DO NOT forget to connect the 24+8-pin power plugs; otherwise, the system will not boot up.
- Use of a PSU with a higher power output is recommended when configuring a system with more power-consuming devices. The system may become unstable or may not boot up if the power is inadequate.
- This motherboard supports ATX2.0 PSU or later version.
- Ensure that your power supply unit (PSU) can provide at least the minimum power required by your system.

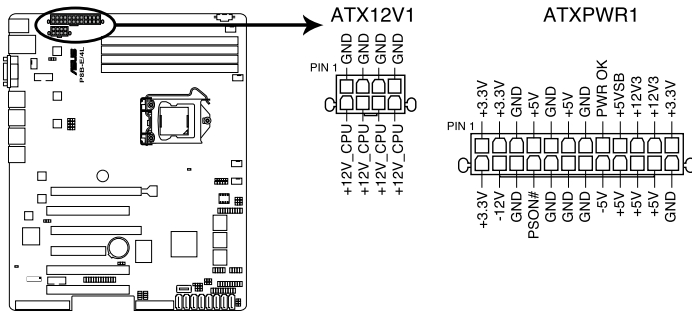

P8B-E/4L 24+8 pin power connectors

13. Parallel port connector (26-1 pin LPT1)

This connector is for a parallel port. Connect the parallel port module cable to this connector, then install the module to a slot opening at the back of the system chassis.

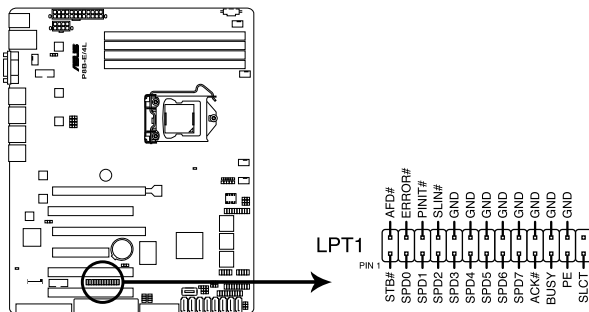

P8B-E/4L Parallel port connector

14. System panel connector (20-pin PANEL1)

This connector supports several chassis-mounted functions.

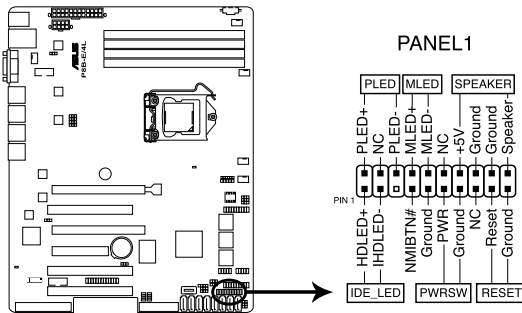

P8B-E/4L System panel connector

1. System power LED (3-pin PLED)

This 3-pin connector is for the system power LED. Connect the chassis power LED cable to this connector. The system power LED lights up when you turn on the system power, and blinks when the system is in sleep mode.

2. Message LED (2-pin MLED)

This 2-pin connector is for the message LED cable that connects to the front message LED. The message LED is controlled by Hardware monitor to indicate an abnormal event occurrence.

3. System warning speaker (4-pin SPEAKER)

This 4-pin connector is for the chassis-mounted system warning speaker. The speaker allows you to hear system beeps and warnings.

4. Hard disk drive activity LED (2-pin HDDLED)

This 2-pin connector is for the HDD Activity LED. Connect the HDD Activity LED cable to this connector. The IDE LED lights up or flashes when data is read from or written to the HDD.

5. Power button/soft-off button (2-pin PWR)

This connector is for the system power button. Pressing the power button turns the system on or puts the system in sleep or soft-off mode depending on the BIOS settings. Pressing the power switch for more than four seconds while the system is ON turns the system OFF.

6. Reset button (2-pin RESET)

This 2-pin connector is for the chassis-mounted reset button for system reboot without turning off the system power.

15. Auxiliary panel connector (20-pin AUX_PANEL1)

This connector is for additional front panel features including front panel SMB, locator LED and switch, chassis intrusion, and LAN LEDs.

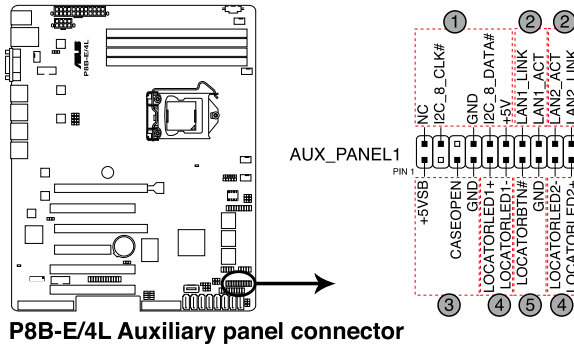

P8B-E/4L Auxiliary panel connector

- 1. Front panel SMB (6-1 pin FPSMB)**
These leads connect the front panel SMBus cable.
- 2. LAN activity LED (2-pin LAN1_LED, LAN2_LED)**
These leads are for Gigabit LAN activity LEDs on the front panel.
- 3. Chassis intrusion (4-1 pin CHASSIS)**
These leads are for the intrusion detection feature for chassis with intrusion sensor or microswitch. When you remove any chassis component, the sensor triggers and sends a high-level signal to these leads to record a chassis intrusion event. The default setting is short CASEOPEN and GND pin by jumper cap to disable the function.
- 4. Locator LED (2-pin LOCATORLED1 and 2-pin LOCATORLED2)**
These leads are for the locator LED1 and LED2 on the front panel. Connect the Locator LED cables to these 2-pin connector. The LEDs will light up when the Locator button is pressed.
- 5. Locator Button/Switch (2-pin LOCATORBTN)**
These leads are for the locator button on the front panel. This button queries the state of the system locator.

4.4 Internal LEDs

1. Standby Power LED

The motherboard comes with a standby power LED. The green LED lights up to indicate that the system is ON, in sleep mode, or in soft-off mode. This is a reminder that you should shut down the system and unplug the power cable before removing or plugging in any motherboard component. The illustration below shows the location of the onboard LED.

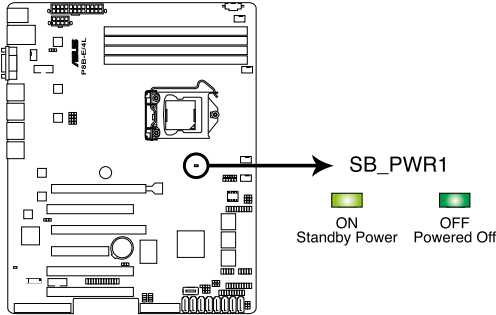

P8B-E/4L Standby power LED

2. BMC LED (BMC_LED1)

The green heartbeat LED blinks per second to indicate that the ASMB5 is working normally.

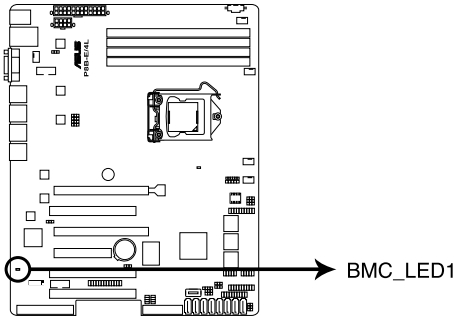

P8B-E/4L BMC LED



The heartbeat LED functions only when you install the ASUS ASMB5.

Chapter 5

This chapter tells how to change the system settings through the BIOS Setup menus. Detailed descriptions of the BIOS parameters are also provided.

BIOS setup

5.1 Managing and updating your BIOS

The following utilities allow you to manage and update the motherboard Basic Input/Output System (BIOS) setup:

1. **ASUS CrashFree BIOS 3** (To recover the BIOS using a bootable USB flash disk drive when the BIOS file fails or gets corrupted.)
2. **ASUS EZ Flash 2** (Updates the BIOS using a USB flash disk.)
3. **BUPDATER utility** (Updates the BIOS in DOS mode using a bootable USB flash disk drive.)

Refer to the corresponding sections for details on these utilities.



Save a copy of the original motherboard BIOS file to a bootable USB flash disk drive in case you need to restore the BIOS in the future. Copy the original motherboard BIOS using the BUPDATER utility.

5.1.1 ASUS CrashFree BIOS 3 utility

The ASUS CrashFree BIOS 3 is an auto recovery tool that allows you to restore the BIOS file when it fails or gets corrupted during the updating process. You can update a corrupted BIOS file using a USB flash drive that contains the updated BIOS file.



Prepare a USB flash drive containing the updated motherboard BIOS before using this utility.

Recovering the BIOS from a USB flash drive

To recover the BIOS from a USB flash drive:

1. Insert the USB flash drive with the original or updated BIOS file to one USB port on the system.
2. The utility will automatically recover the BIOS. It resets the system when the BIOS recovery finished.



DO NOT shut down or reset the system while recovering the BIOS! Doing so would cause system boot failure!



The recovered BIOS may not be the latest BIOS version for this motherboard. Visit the ASUS website at www.asus.com to download the latest BIOS file.

5.1.2 ASUS EZ Flash Utility

The ASUS EZ Flash Utility feature allows you to update the BIOS without having to use a DOS-based utility.



Before you start using this utility, download the latest BIOS from the ASUS website at www.asus.com.

To update the BIOS using EZ Flash Utility

1. Insert the USB flash disk that contains the latest BIOS file to the USB port.
2. Enter the BIOS setup program. Go to the **Tool** menu to select **ASUS EZ Flash Utility** and press <Enter> to enable it.

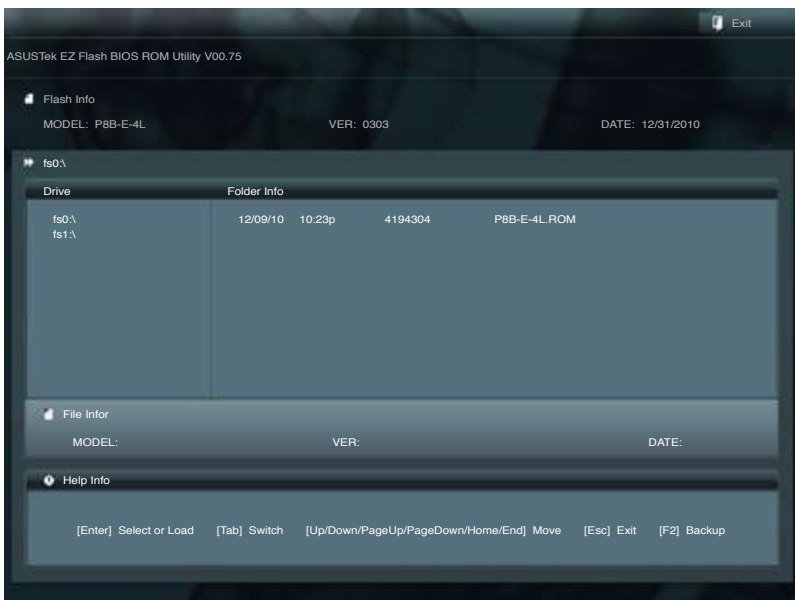

3. Press <Tab> to switch to the **Drive** field.
4. Press the Up/Down arrow keys to find the USB flash disk that contains the latest BIOS, and then press <Enter>.
5. Press <Tab> to switch to the **Folder Info** field.
6. Press the Up/Down arrow keys to find the BIOS file, and then press <Enter> to perform the BIOS update process. Reboot the system when the update process is done.



-
- This function can support devices such as a USB flash disk with FAT 32/16 format and single partition only.
 - DO NOT shut down or reset the system while updating the BIOS to prevent system boot failure!
-



Ensure to load the BIOS default settings to ensure system compatibility and stability. Press <F5> and select **Yes** to load the BIOS default settings.

5.1.3 BUPDATER utility



The succeeding BIOS screens are for reference only. The actual BIOS screen displays may not be the same as shown.

The BUPDATER utility allows you to update the BIOS file in DOS environment using a bootable USB flash disk drive with the updated BIOS file.

Updating the BIOS file

To update the BIOS file using the BUPDATER utility:

1. Visit the ASUS website at www.asus.com and download the latest BIOS file for the motherboard. Save the BIOS file to a bootable USB flash disk drive.
2. Copy the BUPDATER utility (BUPDATER.exe) from the ASUS support website at support.asus.com to the bootable USB flash disk drive you created earlier.
3. Boot the system in DOS mode, then at the prompt, type:

```
BUPDATER /i [filename] .ROM
```

where [filename] is the latest or the original BIOS file on the bootable USB flash disk drive, then press <Enter>.

```
A:\>BUPDATER /i [file name] .ROM
```

- The utility verifies the file, then starts updating the BIOS file.

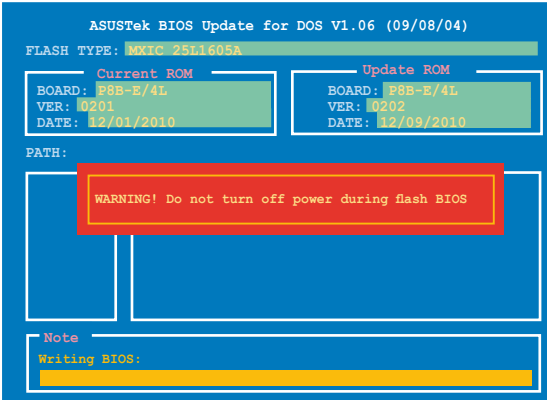

DO NOT shut down or reset the system while updating the BIOS to prevent system boot failure!

- The utility returns to the DOS prompt after the BIOS update process is completed. Reboot the system from the hard disk drive.

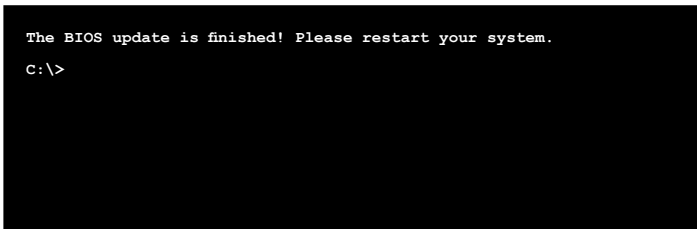

5.2 BIOS setup program

This motherboard supports a programmable firmware chip that you can update using the provided utility described in section **5.1 Managing and updating your BIOS**.

Use the BIOS Setup program when you are installing a motherboard, reconfiguring your system, or prompted to “Run Setup.” This section explains how to configure your system using this utility.

Even if you are not prompted to use the Setup program, you can change the configuration of your computer in the future. For example, you can enable the security password feature or change the power management settings. This requires you to reconfigure your system using the BIOS Setup program so that the computer can recognize these changes and record them in the CMOS RAM of the firmware chip.

The firmware chip on the motherboard stores the Setup utility. When you start up the computer, the system provides you with the opportunity to run this program. Press during the Power-On Self-Test (POST) to enter the Setup utility; otherwise, POST continues with its test routines.

If you wish to enter Setup after POST, restart the system by pressing <Ctrl+Alt+Delete>, or by pressing the reset button on the system chassis. You can also restart by turning the system off and then back on. Do this last option only if the first two failed.

The Setup program is designed to make it as easy to use as possible. Being a menu-driven program, it lets you scroll through the various sub-menus and make your selections from the available options using the navigation keys.



-
- The default BIOS settings for this motherboard apply for most conditions to ensure optimum performance. If the system becomes unstable after changing any BIOS settings, load the default settings to ensure system compatibility and stability. Press <F5> and select **Yes** to load the BIOS default settings.
 - The BIOS setup screens shown in this section are for reference purposes only, and may not exactly match what you see on your screen.
 - Visit the ASUS website (www.asus.com) to download the latest BIOS file for this motherboard.
-

5.2.1 BIOS menu screen

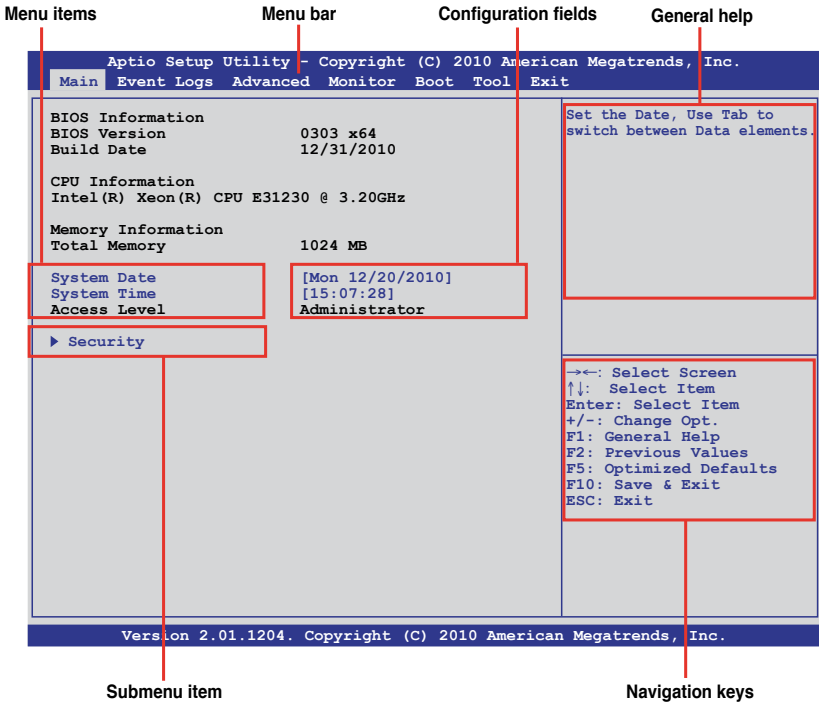

5.2.2 Menu bar

The menu bar on top of the screen has the following main items:

- Main** For changing the basic system configuration
- Event Logs** For changing the event log settings
- Advanced** For changing the advanced system settings
- Monitor** For displaying the system temperature, power status, and changing the fan settings
- Boot** For changing the system boot configuration
- Tool** For configuring options for special functions
- Exit** For selecting the exit options

To select an item on the menu bar, press the right or left arrow key on the keyboard until the desired item is highlighted.

5.2.3 Menu items

The highlighted item on the menu bar displays the specific items for that menu. For example, selecting **Main** shows the Main menu items.

The other items (Event Logs, Advanced, Monitor, Boot, Tool, and Exit) on the menu bar have their respective menu items.

5.2.4 Submenu items

A solid triangle before each item on any menu screen means that the item has a submenu. To display the submenu, select the item and press <Enter>.

5.2.5 Navigation keys

At the bottom right corner of a menu screen are the navigation keys for the BIOS setup program. Use the navigation keys to select items in the menu and change the settings.

5.2.6 General help

At the top right corner of the menu screen is a brief description of the selected item.

5.2.7 Configuration fields

These fields show the values for the menu items. If an item is user-configurable, you can change the value of the field opposite the item. You cannot select an item that is not user-configurable.

A configurable field is enclosed in brackets, and is highlighted when selected. To change the value of a field, select it and press <Enter> to display a list of options.

5.2.8 Pop-up window

Select a menu item and press <Enter> to display a pop-up window with the configuration options for that item.

5.2.9 Scroll bar

A scroll bar appears on the right side of a menu screen when there are items that do not fit on the screen. Press the Up/Down arrow keys or <Page Up> /<Page Down> keys to display the other items on the screen.

5.3 Main menu

When you enter the BIOS Setup program, the Main menu screen appears. The Main menu provides you an overview of the basic system information, and allows you to set the system date, time, language, and security settings.

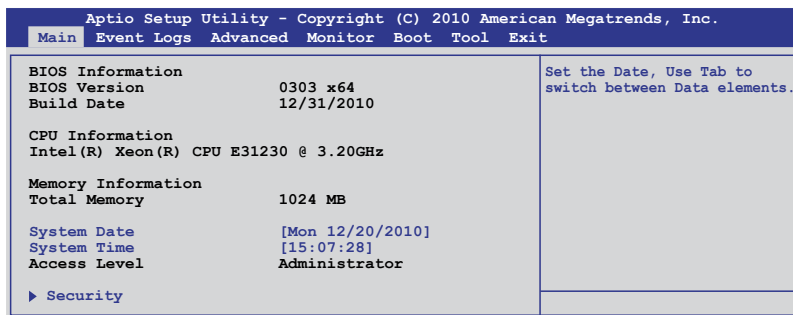

5.3.1 System Date [Day xx/xx/xxxx]

Allows you to set the system date.

5.3.2 System Time [xx:xx:xx]

Allows you to set the system time.

5.3.3 Security

The Security menu items allow you to change the system security settings.

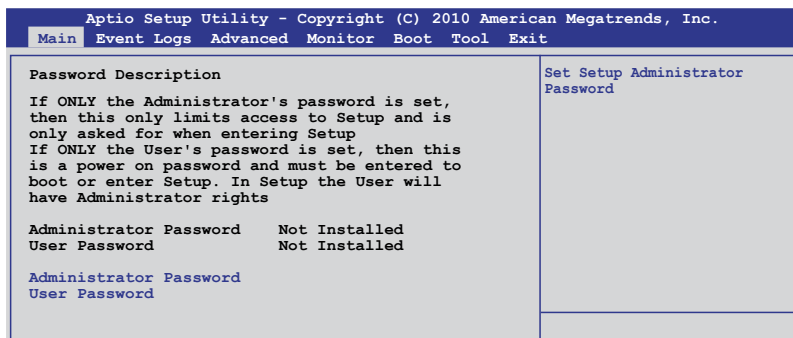

- If you have forgotten your BIOS password, erase the CMOS Real Time Clock (RTC) RAM to clear the BIOS password. See section 4.2 Jumpers for information on how to erase the RTC RAM.
- The **Administrator** or **User Password** items on top of the screen show the default **Not Installed**. After you set a password, these items show **Installed**.

Administrator Password

If you have set an administrator password, we recommend that you enter the administrator password for accessing the system. Otherwise, you might be able to see or change only selected fields in the BIOS setup program.

To set an administrator password:

1. Select the **Administrator Password** item and press <Enter>.
2. From the **Create New Password** box, key in a password, then press <Enter>.
3. Confirm the password when prompted.

To change an administrator password:

1. Select the **Administrator Password** item and press <Enter>.
2. From the **Enter Current Password** box, key in the current password, then press <Enter>.
3. From the **Create New Password** box, key in a new password, then press <Enter>.
4. Confirm the password when prompted.

To clear the administrator password, follow the same steps as in changing an administrator password, but press <Enter> when prompted to create/confirm the password. After you clear the password, the **Administrator Password** item on top of the screen shows **Not Installed**.

User Password

If you have set a user password, you must enter the user password for accessing the system. The **User Password** item on top of the screen shows the default **Not Installed**. After you set a password, this item shows **Installed**.

To set a user password:

1. Select the **User Password** item and press <Enter>.
2. From the **Create New Password** box, key in a password, then press <Enter>.
3. Confirm the password when prompted.

To change a user password:

1. Select the **User Password** item and press <Enter>.
2. From the **Enter Current Password** box, key in the current password, then press <Enter>.
3. From the **Create New Password** box, key in a new password, then press <Enter>.
4. Confirm the password when prompted.

To clear the user password, follow the same steps as in changing a user password, but press <Enter> when prompted to create/confirm the password. After you clear the password, the **User Password** item on top of the screen shows **Not Installed**.

5.4 Event Logs menu

The Event Logs menu items allow you to change the event log settings and view the system event logs.

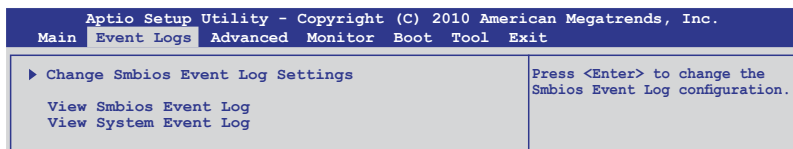

Change Smbios Event Log Settings

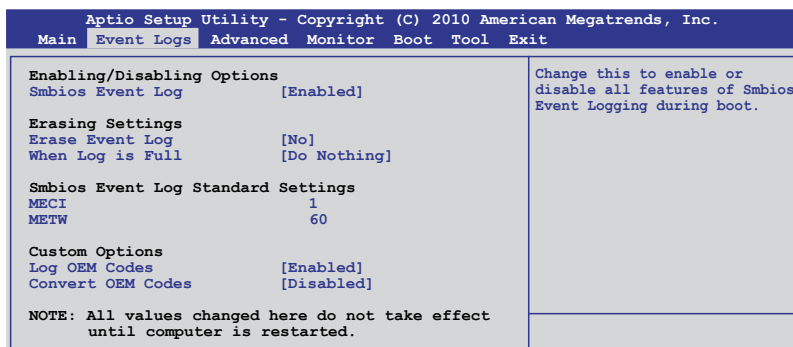

Smbios Event Log [Enabled]

Allows you to enable or disable all features of Smbios event logging.
Configuration option: [Disabled] [Enabled]

Erase Event Log [No]

Allows you to select the options for erasing Smbios event log.
Configuration options: [No] [Yes, Next reset] [Yes, Every reset]

When Log is Full [Do Nothing]

Allows you to select the options for reaction when the event logs are full.
Configuration options: [Do Nothing] [Erase Immediately]

MECI [xx]

Allows you to adjust value for the MECI (Multiple Event Count Increment), which is the number of occurrences of a duplicate event that must pass before the multiple-event counter associated with log entry is updated. Use the <+> and <-> keys to adjust the value. The values range from 1 to 255.

METW [xx]

Allows you to adjust value for the METW (Multiple Event Time Window), which is the number of minutes that must pass between duplicate log entries which utilize a multiple-event counter. Use the <+> and <-> keys to adjust the value. The values range from 0 to 99.

Log OEM Codes [Enabled]

Allows you to enable or disable the logging of EFI status codes as OEM codes. Configuration option: [Disabled] [Enabled]

Convert OEM Codes [Disabled]

Allows you to enable or disable the converting of EFI status codes to standard Smbios types. Configuration option: [Disabled] [Enabled]

View Smbios Event Log

Press <Enter> to view the Smbios event logs.

View System Event Log

Press <Enter> to view the system event logs.

5.5 Advanced menu

The Advanced menu items allow you to change the settings for the CPU and other system devices.



Take caution when changing the settings of the Advanced menu items. Incorrect field values can cause the system to malfunction.

Aptio Setup Utility - Copyright (C) 2010 American Megatrends, Inc.	
Main Event Logs Advanced Monitor Boot Tool Exit	
<ul style="list-style-type: none">▶ ACPI Settings▶ Trusted Computing▶ WHEA Configuration▶ CPU Configuration▶ North Bridge▶ South Bridge▶ SATA Configuration▶ Intel TXT (LT) Configuration▶ USB Configuration▶ ME Subsystem▶ Onboard Devices Configuration▶ AFM▶ Serial Port Console Redirection▶ Network Stack	System ACPI Parameters

5.5.1 ACPI Settings

Aptio Setup Utility - Copyright (C) 2010 American Megatrends, Inc.	
Advanced	
Enable ACPI Auto Configuration [Disabled]	Enables or Disables BIOS ACPI Auto Configuration.
ACPI Sleep State [S3 (Suspend to RAM)]	

Enable ACPI Auto Configuration [Disabled]

Allows you to enable or disable ACPI Auto Configuration.

Configuration options: [Disabled] [Enabled]

ACPI Sleep State [S3 (Suspend to RAM)]

Allows you to set the ACPI Sleep State.

Configuration options: [Suspend Disabled] [S1 (CPU Stop Clock)] [S3 (Suspend to RAM)]

5.5.2 Trusted Computing

Aptio Setup Utility - Copyright (C) 2010 American Megatrends, Inc.	
Advanced	
TPM Configuration TPM SUPPORT [Disabled] Current TPM Status Information NO TPM Hardware	Enables or Disables TPM support. O.S. will not show TPM. Reset of platform is required.

TPM SUPPORT [Disabled]

Allows you to enable or disable the TPM support.

Configuration options: [Disabled] [Enabled]

5.5.3 WHEA Configuration

Aptio Setup Utility - Copyright (C) 2010 American Megatrends, Inc.	
Advanced	
WHEA Support [Enabled]	Enable or disable Windows Hardware Error Architecture.

WHEA Support [Enabled]

Allows you to enable or disable the Windows Hardware Error Architecture support.

Configuration options: [Disabled] [Enabled]

5.5.4 CPU Configuration

The items in this menu show the CPU-related information that the BIOS automatically detects. Some items may not appear if your CPU does not support the related functions.

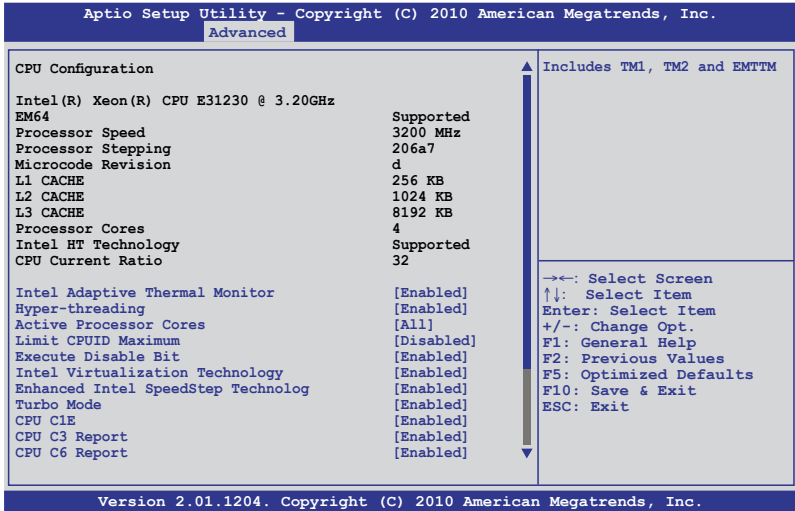

Scroll down for more items.

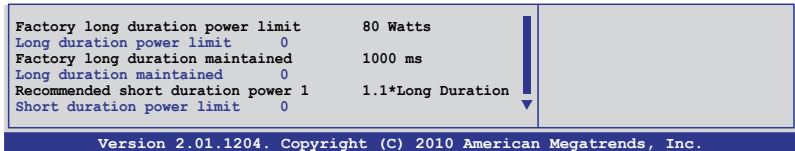

Intel Adaptive Thermal Monitor [Enabled]

Allows you to enable or disable the CPU thermal monitor function.

Configuration options: [Disabled] [Enabled]

Hyper-threading [Enabled]

Allows you to enable or disable the Intel Hyper-Threading Technology function.

When disabled, only one thread per activated core is enabled.

Configuration options: [Enabled] [Disabled]

Active Processor Cores [All]

Allows you to choose the number of CPU cores to activate in each processor

package. Configuration options: [All] [1] [2] [3]

Limit CPUID Maximum [Disabled]

Setting this item to [Enabled] allows legacy operating systems to boot even without support for CPUs with extended CPUID functions.

Configuration options: [Disabled] [Enabled]

Execute Disable Bit [Enabled]

Allows you to enable or disable the No-Execution Page Protection Technology.

Setting this item to [Disabled] forces the XD feature flag to always return to zero (0).

Configuration options: [Disabled] [Enabled]

Intel Virtualization Tech [Enabled]

The Intel® Virtualization Technology allows a hardware platform to run multiple operating systems separately and simultaneously, enabling one system to virtually function as several systems. Configuration options: [Disabled] [Enabled]

Enhanced Intel SpeedStep Technology [Enabled]

Allows you to enable or disable the Enhanced Intel® SpeedStep Technology (EIST).

Configuration options: [Disabled] [Enabled]

Turbo Mode [Enabled]

This item appears only when you set the **Enhanced Intel SpeedStep Technology** item to [Enabled] and allows you to enable or disable the Intel® Turbo Mode Technology. Configuration options: [Disabled] [Enabled]

CPU C1E [Enabled]

[Enabled] Enables the C1E support function. This item should be enabled in order to enable the Enhanced Halt State.

[Disabled] Disables this function.

CPU C3 Report [Enabled]

Allows you to disable or enable the CPU C3 report to OS.

CPU C6 Report [Enabled]

Allows you to disable or enable the CPU C6 report to OS.

5.5.5 North Bridge

The North Bridge is built in the CPU.

Aptio Setup Utility - Copyright (C) 2010 American Megatrends, Inc.	
Advanced	
Memory Information	Low MMIO resources align at 64MB/1024MB
TOTAL Memory	1024 MB
DIMM_A0	0 MB (DDR3 1333)
DIMM_A1	1024 MB (DDR3 1333)
DIMM_B0	0 MB (DDR3 1333)
DIMM_B1	0 MB (DDR3 1333)
Low MMIO Align	[64M]
DMI Gen2	[Enabled]
VT-d	[Disabled]
Initiate Graphic Adapter	[PEG/PCI]

Low MMIO Align [64M]

Allows you to select the options for the Low MMIO Align.

Configuration options: [64M] [1024M]

DMI Gen2 [Enabled]

Allows you to enable or disable the DMI Gen2.

Configuration options: [Disabled] [Enabled]

VT-d [Disabled]

Allows you to enable or disable the VT-d.

Configuration options: [Disabled] [Enabled]

Initiate Graphic Adapter [PEG/PCI]

Allows you to decide which graphics controller to use as the primary boot device.

Configuration options: [PCI/PEG] [PEG/PCI]

5.5.6 South Bridge

Aptio Setup Utility - Copyright (C) 2010 American Megatrends, Inc.	
Advanced	
SB Chipset Configuration	Enabled/disabled the High Precision Event Timer.
High Precision Event Timer Configuration	
High Precision Timer	[Enabled]

High Precision Timer [Enabled]

Allows you to enable or disable the High Precision Event Timer.

Configuration options: [Enabled] [Disabled]

5.5.7 SATA Configuration

While entering Setup, the BIOS automatically detects the presence of SATA devices. The SATA Port items show **Not Present** if no SATA device is installed to the corresponding SATA port.

Aptio Setup Utility - Copyright (C) 2010 American Megatrends, Inc.	
Advanced	
SATA Configuration	
SATA Mode	[IDE Mode]
Serial-ATA Controller 0	[Enhanced]
Serial-ATA Controller 1	[Enhanced]
S.M.A.R.T. Status Check	[Enabled]
SATA Port1	ST3160812AS (160.0GB)
SATA Port2	ST3160812AS (160.0GB)
SATA Port3	ASUS CB-521 ATAPI
SATA Port4	Not Present
SATA Port5	Not Present
SATA Port6	Not Present

(1) IDE Mode. (2) AHCI Mode.
(3) RAID Mode.

SATA Mode [IDE Mode]

Allows you to set the SATA configuration.

Configuration options: [Disabled] [IDE Mode] [AHCI Mode] [RAID Mode]



- If you want to use the Serial ATA hard disk drives as Parallel ATA physical storage devices, keep the default setting [IDE Mode].
- If you want the Serial ATA hard disk drives to use the Advanced Host Controller Interface (AHCI), set this item to [AHCI Mode]. The AHCI allows the onboard storage driver to enable advanced Serial ATA features that increases storage performance on random workloads by allowing the drive to internally optimize the order of commands.
- If you want to create RAID sets with LSI MegaRAID utility, or Intel® Matrix Storage Technology from the Serial ATA hard disk drives, set this item to [RAID Mode].

Serial-ATA Controller 0 [Enhanced]

This item appears only when you set the **SATA Mode** item to [IDE Mode]. Set to [Enhanced] to support two SATA 6.0 Gb/s and two SATA 3.0 Gb/s devices. Set to [Compatible] when using Windows 98/NT/2000/MS-DOS. Up to four SATA devices are supported under these operating systems.

Serial-ATA Controller 1 [Enhanced]

This item appears only when you set the **SATA Mode** item to [IDE Mode]. Set to [Enhanced] to support two SATA 3.0 Gb/s devices.

S.M.A.R.T. Status Check [Enabled]

S.M.A.R.T. (Self-Monitoring, Analysis and Reporting Technology) is a monitor system. When read/write of your hard disk errors occur, this feature allows the hard disk to report warning messages during the POST.

Configuration options: [Enabled] [Disabled]

5.5.8 Intel TXT(LT) Configuration

Aptio Setup Utility - Copyright (C) 2010 American Megatrends, Inc.	
Advanced	
Intel Trusted Execution Technology Configuration Intel TXT support only can be enabled/disabled if SMX is enabled. VT and VT-d support must also be enabled prior to TXT.	Enables Legacy USB support. AUTO option disables legacy support if no USB devices are connected. DISABLE option will keep USB devices available only for EFI applications.
Secure Mode Extensions (SMX) Enabled	
Intel TXT(LT) Support [Disabled]	

Intel TXT(LT) Support [Disabled]

Allows you to enable or disable the Intel Trusted Execution Technology (TXT) feature. Configuration options: [Disabled] [Enabled]



The **Intel TXT(LT) Support** item requires a Trusted Platform Module (TPM) to be installed on the motherboard to enable.

5.5.9 USB Configuration

Aptio Setup Utility - Copyright (C) 2010 American Megatrends, Inc.	
Advanced	
USB Configuration	Enables Legacy USB support. AUTO option disables legacy support if no USB devices are connected. DISABLE option will keep USB devices available only for EFI applications.
USB Devices 1 Mouse, 2 Hubs	
Legacy USB Support [Enabled]	
EHCI Hand-off [Disabled]	
USB hardware delays and time-out:	
USB transfer time-out [20 sec]	
Device reset time-out [20 sec]	
Device power-up delay [Auto]	



The **USB Devices** item shows the auto-detected values. If no USB device is detected, the item shows **None**.

Legacy USB Support [Enabled]

Allows you to enable or disable support for legacy USB devices. Setting to [Auto] allows the system to detect the presence of USB devices at startup. If detected, the USB controller legacy mode is enabled. If no USB device is detected, the legacy USB support is disabled. Configuration options: [Disabled] [Enabled] [Auto]

EHCI Hand-off [Disabled]

Enables or disables the BIOS EHCI hand-off support. Configuration options: [Disabled] [Enabled]

USB transfer time-out [20 sec]

Allows you to select the USB transfer time-out value.
Configuration options: [1 sec] [5 sec] [10 sec] [20 sec]

Device reset time-out [20 sec]

Allows you to select the USB device reset time-out value.
Configuration options: [10 sec] [20 sec] [30 sec] [40 sec]

Device power-up delay [Auto]

Configuration options: [Auto] [Manual]

Device power-up delay in seconds [XX]

This item appears only when you set the **Device power-up delay** item to [manual]. Use the <+> and <-> keys to adjust the value. The values range from 1 to 40 with a one-second interval.

5.5.10 ME Subsystem

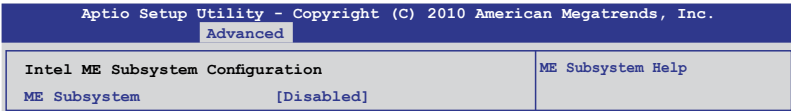

ME Subsystem [Disabled]

Allows you to enable or disable the Intel Management Engine (Intel ME) Subsystem that performs various tasks while the system is in sleep, during the boot process and when the system is running. Configuration options: [Enabled] [Disabled]

5.5.11 Onboard Devices Configuration

The Onboard Devices Configuration menu items allow you to change the advanced settings for onboard devices.

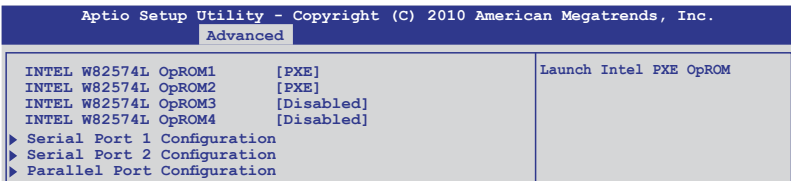

INTEL W82574L OpROM1/OpROM2 [PXE]

INTEL W82574L OpROM3/OpROM4 [Disabled]

Allows you to select the options for the OptionRom of the Intel LAN controllers.
Configuration options: [Disabled] [PXE] [iSCSI]

Serial Port 1/2 Configuration

The sub-items in this menu allow you to set the serial port 1/2 configuration.

Serial Port [Enabled]

Allows you to enable or disable the serial port (COM).
Configuration options: [Enabled] [Disabled]

Change Settings [Auto]

Allows you to select the serial port base address.
Configuration options: [Auto] [IO=3F8h; IRQ=4]
[IO=3F8h; IRQ=3, 4, 5, 6, 7, 9, 10, 11, 12]
[IO=2F8h; IRQ=3, 4, 5, 6, 7, 9, 10, 11, 12]
[IO=3E8h; IRQ=3, 4, 5, 6, 7, 9, 10, 11, 12]
[IO=2E8h; IRQ=3, 4, 5, 6, 7, 9, 10, 11, 12]

Parallel Port Configuration

The sub-items in this menu allow you to set the parallel port configuration.

Parallel Port [Enabled]

Allows you to enable or disable the parallel port (LPT/LPTE).
Configuration options: [Enabled] [Disabled]

Change Settings [Auto]

Allows you to select an optimal setting for the super IO device.
Configuration options: [Auto] [IO=378h; IRQ=5]
[IO=378h; IRQ=5, 6, 7, 9, 10, 11, 12] [IO=278h; IRQ=5, 6, 7, 9, 10, 11, 12]
[IO=3BCh; IRQ=5, 6, 7, 9, 10, 11, 12]

Device Mode [STD Printer Mode]

Allows you to select the printer port mode.
Configuration options: [STD Printer mode] [SPP Mode] [EPP-1.9 and SPP Mode] [EPP-1.7 and SPP Mode] [ECP Mode] [ECP and EPP 1.9 Mode] [ECP and EPP 1.7 Mode]

5.5.12 APM

Aptio Setup Utility - Copyright (C) 2010 American Megatrends, Inc.		
Advanced		
Restore AC Power Loss	[Power Off]	Specify what state to go to when power is re-applied after a power failure (G3 state).
EuP Ready	[Disabled]	
Power On By PCI	[Disabled]	
Power On By PCIE	[Disabled]	
Power On By Ring	[Disabled]	
Power On By RTC	[Disabled]	

Restore AC Power Loss [Power Off]

When set to [Power Off], the system goes into off state after an AC power loss. When set to [Power On], the system will reboot after an AC power loss. When set to [Last State], the system goes into either off or on state, whatever the system state was before the AC power loss.

Configuration options: [Power Off] [Power On] [Last State]

EuP Ready [Disabled]

When set to [Enabled], all other PME options will be switched off.

Configuration options: [Disabled] [Enabled]

Power On By PCI [Disabled]

[Disabled] Disables the PME to wake up from S5 by PCI devices.

[Enabled] Allows you to turn on the system through a PCI LAN or modem card. This feature requires an ATX power supply that provides at least 1A on the +5VSB lead.

Power On By PCIE [Disabled]

[Disabled] Disables the PCIE devices to generate a wake event.

[Enabled] Enables the PCIE devices to generate a wake event.

Power On By Ring [Disabled]

[Disabled] Disables Ring to generate a wake event.

[Enabled] Enables Ring to generate a wake event.

Power On By RTC [Disabled]

[Disabled] Disables RTC to generate a wake event.

[Enabled] When set to [Enabled], the items **RTC Alarm Date (Days)** and **Hour/Minute/Second** will become user-configurable with set values.

5.5.13 Serial Port Console Redirection

Aptio Setup Utility - Copyright (C) 2010 American Megatrends, Inc.	
Advanced	
Redirection After BIOS POST	[Disabled]
COM0	
Console Redirection	[Disabled]
▶ Console Redirection Settings	
COM1	
Console Redirection	[Enabled]
▶ Console Redirection Settings	

Redirection After BIOS POST [Disabled]

Enables or disables the redirection after BIOS POST feature.

Configuration options: [Disabled] [Enabled]

COM0

Console Redirection [Disabled]

Enables or disables the console redirection feature.

Configuration options: [Disabled] [Enabled]

Console Redirection Settings

This item becomes configurable only when you enable the **Console Redirection** item. The settings specify how the host computer and the remote computer (which the user is using) will exchange data. Both computers should have the same or compatible settings.

Terminal Type [VT-UTF8]

Allows you to set the terminal type.

[VT100] ASCII char set.

[VT100+] Extends VT100 to support color, function keys, et.

[VT-UTF8] Uses UTF8 encoding to map Unicode chars onto 1 or more bytes

[ANSI] Extended ASCII char set

Bits per second [57600]

Selects serial port transmission speed. The speed must be matched on the other side. Long or noisy lines may require lower speeds.

Configuration options: [9600] [19200] [38400] [57600] [115200]

Data Bits [8]

Configuration options: [7] [8]

Parity [None]

A parity bit can be sent with the data bits to detect some transmission errors. [Mark] and [Space] parity do not allow for error detection.

[Even] parity bit is 0 if the num of 1's in the data bits is even

[Odd] parity bit is 0 if num of 1's in the data bits is odd

[Mark] parity bit is always 1

[Space] parity bit is always 0

Stop Bits [1]

Stop bits indicate the end of a serial data packet. (A start bit indicates the beginning.) The standard setting is 1 stop bit. Communication with slow devices may require more than 1 stop bit. Configuration options: [1] [2]

Flow Control [None]

Flow control can prevent data loss from buffer overflow. When sending data, if the receiving buffers are full, a “stop” signal can be sent to stop the data flow. Once the buffers are empty, a “start” signal can be sent to re-start the flow. Hardware flow control uses two wires to send start/stop signals. Configuration options: [None] [Hardware RTS/CTS]

Recorder Mode [Disabled]

With this mode enabled only text will be sent. This is to capture Terminal data. Configuration options: [Disabled] [Enabled]

Legacy OS Redirction Resolution [80x24]

Configures the number of rows and columns supported on legacy OS. Configuration options: [80x24] [80x25]

COM1

Console Redirection [Enabled]

Enables or disables the console redirection feature.

Configuration options: [Disabled] [Enabled]

Console Redirection Settings

Please refer to the description of the **Console Redirection Settings** item under COM0 for details.

5.5.14 Network Stack

Aptio Setup Utility - Copyright (C) 2010 American Megatrends, Inc.		
Advanced		
Network stack	[Disable]	Enable/Disable the network stack (Pxe and UEFI)

Network stack [Disable]

Enables or disables the network stack feature.

Configuration options: [Disable] [Enable]

5.6 Monitor menu

The Monitor menu displays the system temperature/power status, and allows you to change the fan settings.

Aptio Setup Utility - Copyright (C) 2010 American Megatrends, Inc.	
Main Event Logs Advanced Monitor Boot Tool Exit	
CPU Temperature (PECI)	[+35°C / +94°F]
MB Temperature	[+35°C / +94°F]
TR1 Temperature	[N/A]
CPU FAN1 Speed	[1305 RPM]
FRNT FAN1 Speed	[N/A]
FRNT FAN2 Speed	[N/A]
FRNT FAN3 Speed	[N/A]
REAR FAN1 Speed	[N/A]
FAN Speed Control	[Generic Mode]
VCORE1	[+1.200 V]
+3.3V	[+3.360 V]
+5V	[+5.160 V]
+12V	[+12.384 V]
VBAT	[+3.408 V]
+3VSB	[+3.422 V]
+1.5V	[+1.496 V]

CPU/MB/TR1 Temperature [xxx°C/xxx°F]

The onboard hardware monitor automatically detects and displays the CPU and motherboard component temperatures. Select **Ignore** if you do not wish to display the detected temperatures.

CPU FAN1 Speed; FRNT FAN1–3 Speed; REAR FAN1 Speed [xxxx RPM] or [Ignore] / [N/A]

The onboard hardware monitor automatically detects and displays the speed of CPU fans, front fans, and rear fan in rotations per minute (RPM). If the fan is not connected to the motherboard, the field shows **N/A**.

Fan Speed Control [Generic Mode]

Allows you to configure the ASUS Smart Fan feature that smartly adjusts the fan speeds for more efficient system operation.

Configuration options: [Full Speed Mode] [High Density Mode] [Generic Mode] [Whisper Mode]

VCORE1 Voltage, 3.3V Voltage, +5V Voltage, +12V Voltage, VBAT Voltage, +3VSB Voltage, +1.5V ICH Voltage

The onboard hardware monitor automatically detects the voltage output through the onboard voltage regulators. Select **Ignore** if you do not want to detect this item.

5.7 Boot menu

The Boot menu items allow you to change the system boot options.

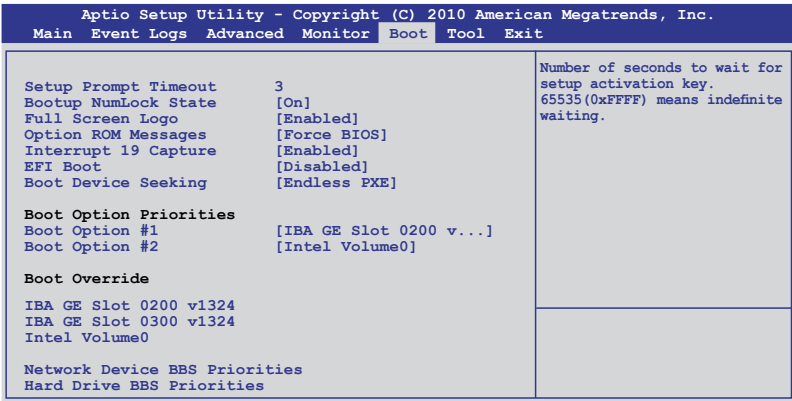

Setup Prompt Timeout [xx]

Use the <+> and <-> keys to adjust the number of seconds to wait for setup activation key.

Bootup NumLock State [On]

Allows you to select the power-on state for the NumLock.
Configuration options: [Off] [On]

Full Screen Logo [Enabled]

Allows you to enable or disable the full screen logo display feature.
Configuration options: [Disabled] [Enabled]



Set this item to [Enabled] to use the ASUS MyLogo2™ feature.

Option ROM Messages [Force BIOS]

Allows you to set the display mode for Options ROM.
Configuration options: [Force BIOS] [Keep Current]

Interrupt 19 Capture [Enabled]

Allows Option ROMs to trap interrupt 19.
Configuration options: [Disabled] [Enabled]

EFI Boot [Disabled]

Enables or disables EFI Boot.
Configuration options: [Disabled] [Enabled]

Boot Device Seeking [Endless PXE]

[Endless PXE] Continuous seek remote boot image until boot image found or user abort (press Ctrl+Alt+Del).

[Normal] Seek remote boot image once then stop.

Boot Option Priorities

These items specify the boot device priority sequence from the available devices. The number of device items that appears on the screen depends on the number of devices installed in the system.



- To select the boot device during system startup, press <F8> when ASUS Logo appears.
- To access Windows OS in Safe Mode, do any of the following:
 - Press <F5> when ASUS Logo appears.
 - Press <F8> after POST.

Boot Override

These items displays the available devices. The number of device items that appears on the screen depends on the number of devices installed in the system. Click an item to start booting from the selected device.

Network Device BBS Priorities

Set the booting order of network devices.

Boot Option #1/#2 [IBA GE Slot 0200 v1324]

Configuration options: [IBA GE Slot 0200 v1324] [IBA GE Slot 0300 v1324]
[Disabled]

5.8 Tool menu

The Tool menu items allow you to configure options for special functions. Select an item then press <Enter> to display the submenu.

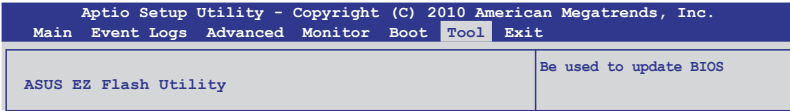

ASUS EZ Flash Utility

Allows you to run ASUS EZ Flash 2. When you press <Enter>. Check section 5.1.2 **ASUS EZ Flash 2 utility** for details.

5.9 Exit menu

The Exit menu items allow you to save or discard your changes to the BIOS items.

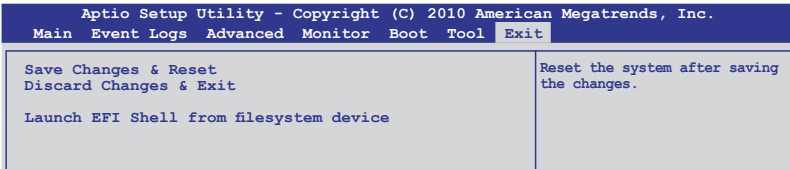

Pressing <Esc> does not immediately exit this menu. Select one of the options from this menu or <F10> from the legend bar to exit.

Save Changes & Reset

Once you are finished making your selections, choose this option from the Exit menu to ensure the values you selected are saved. When you select this option or if you press <F10>, a confirmation window appears. Select **Yes** to save changes and exit.

Discard Changes & Exit

This option allows you to exit the Setup program without saving your changes. When you select this option or if you press <Esc>, a confirmation window appears. Select **Yes** to discard changes and exit.

Launch EFI Shell from filesystem device

This option allows you to attempt to launch the EFI Shell application (shellx64.efi) from one of the available filesystem devices.

Chapter 6

This chapter provides instructions for setting up, creating and configuring RAID sets using the available utilities.

RAID configuration

6.1 Setting up RAID

The motherboard comes with the Intel® C204 controller that supports the following SATA RAID solutions:

- **LSI MegaRAID software RAID Configuration Utility** (default) with RAID 0, RAID 1, and RAID 10 support (for both Linux and Windows OS).
- **Intel Rapid Storage Technology** with RAID 0, RAID 1, RAID 10, and RAID 5 support (for Windows OS only).

6.1.1 RAID definitions

RAID 0 (*Data striping*) optimizes two identical hard disk drives to read and write data in parallel, interleaved stacks. Two hard disks perform the same work as a single drive but at a sustained data transfer rate, double that of a single disk alone, thus improving data access and storage. Use of two new identical hard disk drives is required for this setup.

RAID 1 (*Data mirroring*) copies and maintains an identical image of data from one drive to a second drive. If one drive fails, the disk array management software directs all applications to the surviving drive as it contains a complete copy of the data in the other drive. This RAID configuration provides data protection and increases fault tolerance to the entire system. Use two new drives or use an existing drive and a new drive for this setup. The new drive must be of the same size or larger than the existing drive.

RAID 10 is data striping and data mirroring combined without parity (redundancy data) having to be calculated and written. With the RAID 10 configuration you get all the benefits of both RAID 0 and RAID 1 configurations. Use four new hard disk drives or use an existing drive and three new drives for this setup.

RAID 5 stripes both data and parity information across three or more hard disk drives. Among the advantages of RAID 5 configuration include better HDD performance, fault tolerance, and higher storage capacity. The RAID 5 configuration is best suited for transaction processing, relational database applications, enterprise resource planning, and other business systems. Use a minimum of three identical hard disk drives for this setup.

6.1.2 Installing hard disk drives

The motherboard supports SATA hard disk drives for RAID set configuration. For optimal performance, install identical drives of the same model and capacity when creating a disk array.

See section **2.4 Hard disk drives** for SATA hard disk drive installation.

6.1.3 RAID controller selection

You can choose either the LSI Software RAID Configuration Utility or the Intel Rapid Storage Technology as the default utility to create RAID set(s). See **5. RAID configuration utility selection** on page 4-6 for details.

6.1.4 Setting the RAID item in BIOS

You must enable the RAID function in the BIOS Setup before creating RAID set(s) using SATA HDDs. To do this:

1. Enter the BIOS Setup during POST.
2. Go to the **Advanced** Menu > **SATA Configuration**, then press <Enter>.
3. Set **SATA Mode** to [RAID Mode]
4. Press <F10> to save your changes and exit the BIOS Setup.



Refer to Chapter 5 for details on entering and navigating through the BIOS Setup.

6.2 LSI Software RAID Configuration Utility

The LSI MegaRAID software RAID configuration utility allows you to create RAID 0, RAID 1, or RAID 10 set(s) from SATA hard disk drives connected to the SATA connectors supported by the motherboard southbridge chip.

To enter the LSI MegaRAID software RAID configuration utility:

1. Turn on the system after installing all the SATA hard disk drives.
2. During POST, the LSI MegaRAID software RAID configuration utility automatically detects the installed SATA hard disk drives and displays any existing RAID set(s). Press <Ctrl> + <M> to enter the utility.

```
LSI MegaRAID Software RAID BIOS Version A.10 09231523R
LSI SATA RAID Found at PCI Bus No:00 Dev No:1F
Device present at Port 0      ST3160812AS      152114MB
Device present at Port 1      ST3160812AS      152114MB
Device present at Port 2      ST3160812AS      152114MB
Device present at Port 3      ST3160812AS      152114MB
Press Ctrl-M or Enter to run LSI Software RAID Setup Utility.
```



- The LSI MegaRAID software RAID configuration utility automatically configures to RAID 1 when the SATA to RAID Mode is enabled.
- The RAID setup screens shown in this section are for reference only and may not exactly match the items on your screen due to the controller version difference.
- When you create RAID sets with the LSI MegaRAID software RAID configuration utility, the boot priority of the SATA optical drive has to be manually adjusted. Otherwise, the system will not boot from the connected SATA ODD.

3. The utility main window appears. Use the arrow keys to select an option from the **Management Menu** and then press <Enter>. Refer to the Management Menu descriptions on the next page.

At the bottom of the screen is the legend box. The keys on the legend box allow you to navigate through the setup menu options or execute commands. The keys on the legend box vary according to the menu level.

```
LSI Software RAID Configuration Utility Ver C.05 Sep 17, 2010
BIOS Version A.10.09231523R

Management Menu
Configure
Initialize
Objects
Rebuild
Check Consistency

Configure VD(s)

Use Cursor Keys to Navigate Between Items And Press Enter To Select An Option
```

Menu	Description
Configure	Allows you to create RAID 0, RAID 1 or RAID 10 set using the Easy Configuration or the New Configuration command. This menu also allows you to view, add, or clear RAID configurations or select the boot drive
Initialize	Allows you to initialize the virtual drives of a created RAID set
Objects	Allows you to initialize virtual drives or change the virtual drive parameters
Rebuild	Allows you to rebuild failed drives
Check Consistency	Allows you to check the data consistency of the virtual drives of a created RAID set

6.2.1 Creating a RAID set

The LSI Software RAID Configuration Utility allows you to create a RAID 0, RAID 1, or RAID 10 set using two types of configurations: **Easy** and **New**.

In **Easy Configuration**, the virtual drive parameters are set automatically.

In **New Configuration**, you manually set the virtual drive parameters.

Using Easy Configuration

To create a RAID set using the **Easy Configuration** option:

1. From the **Management Menu**, select **Configure > Easy Configuration**, and then press <Enter>.

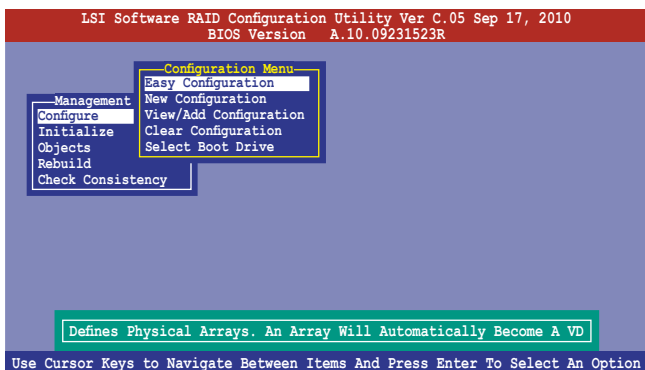

- The **ARRAY SELECTION MENU** displays the available drives connected to the SATA ports. Use the up/down arrow keys to select the drives you want to include in the RAID set, and then press <Space>. When selected, the drive indicator changes from **READY** to **ONLIN A[X]-[Y]**, where X is the array number, and Y is the drive number.

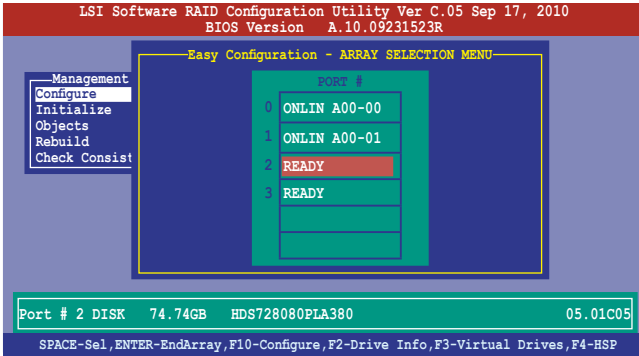

- The information of the selected hard disk drive displays at the bottom of the screen.
- You need at least two identical hard disk drives when creating a RAID 1 set.
- You need at least four identical hard disk drives when creating a RAID 10 set.

- Select all the drives required for the RAID set, and then press <F10> to configure array setting.
- Press <Space> to select the configurable array.

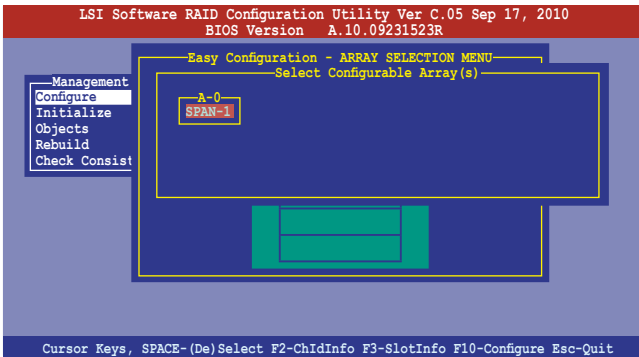

5. Press <F10> again, the virtual drive information appears including a **Virtual Drive** menu that allows you to change the virtual drive parameters.

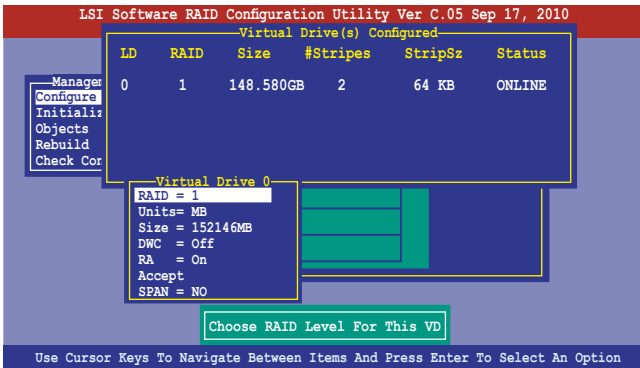

6. Select **RAID** from the **Virtual Drive** sub-menu, and then press <Enter>.
7. Select the **RAID** level from the menu, and then press <Enter>.

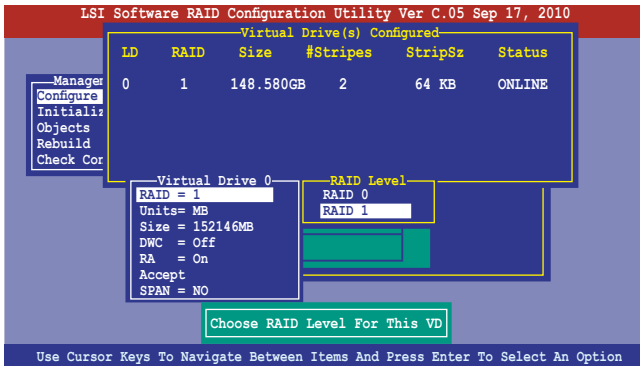

8. Select **Units** from the **Virtual Drive** sub-menu, and then press <Enter>.
9. Select the units for virtual drive size from the menu, and then press <Enter>.

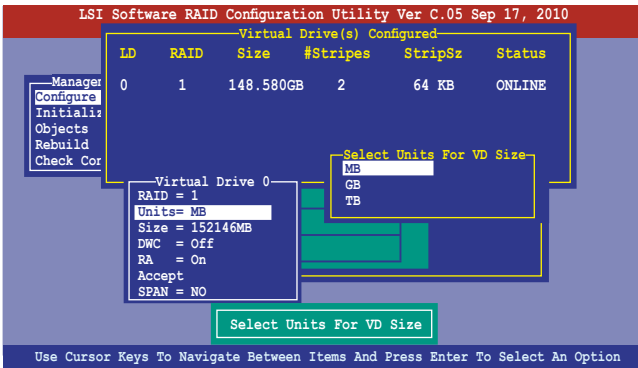

10. When creating a **RAID 1** or a **RAID 10** set, select **DWC** from the **Virtual Drive** menu, and then press <Enter>.
- When creating a **RAID 0** set, proceed to step 12.
11. Select **On** to enable the **Disk Write Cache** setting, and then press <Enter>.

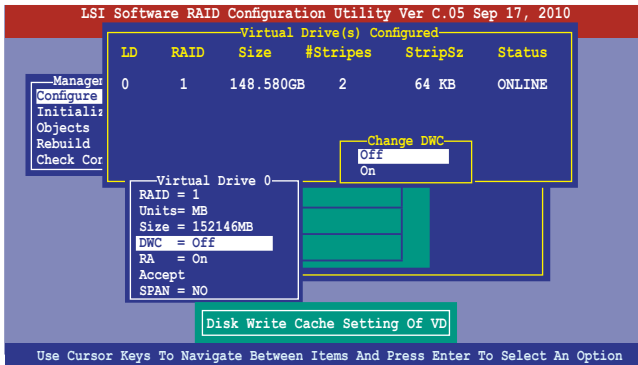

Enabling DWC can improve the performance, but with the risk of data loss.

12. When finished setting the selected virtual drive configuration, select **Accept** from the menu, and then press <Enter>.

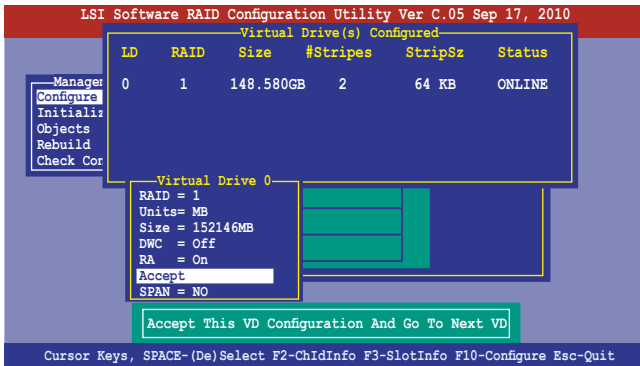

13. Follow step 2 to 12 to configure additional virtual drives.
14. Press <Esc> to finish RAID configuration. When prompted to save configuration, select **Yes** from the menu, and then press <Enter>.

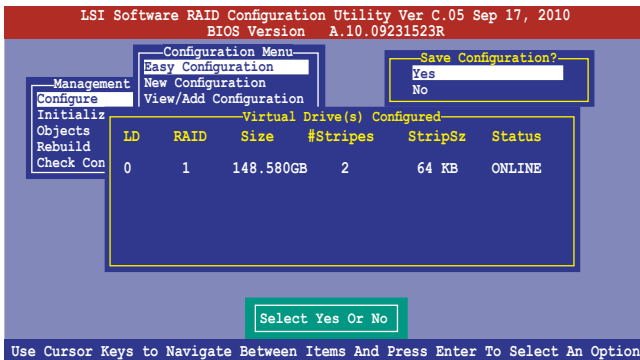

Using New Configuration



When a RAID set already exists, using the **New Configuration** command erases the existing RAID configuration data. If you do not want to delete the existing RAID set, use the **View/Add Configuration** command to view or create another RAID configuration.

To create a RAID set using the **New Configuration** option

1. From the **Management Menu**, select **Configure > New Configuration**, and then press <Enter>.

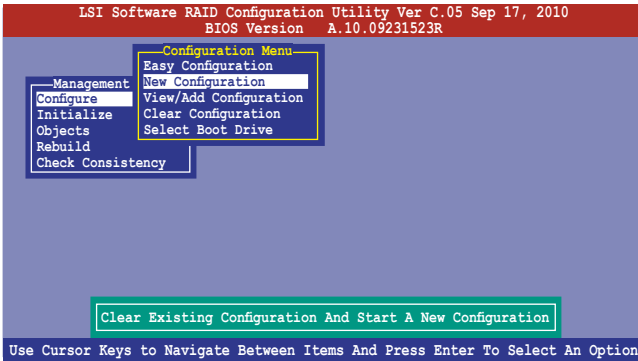

2. Follow step 2 to 9 of the previous section: **Using Easy Configuration**.
3. Select **Size** from the **Virtual Drive** menu, and then press <Enter>.
4. Key-in the desired virtual drive size, and then press <Enter>.

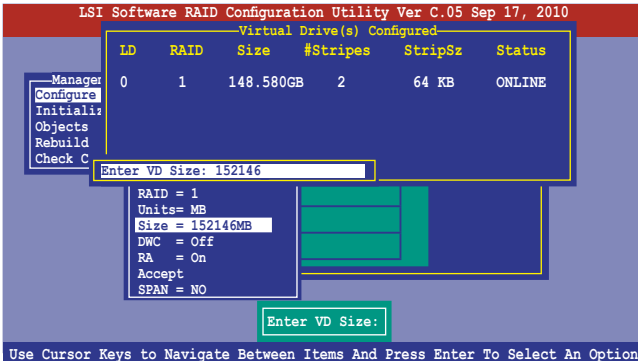

5. Follow step 10 to 14 of the previous section: **Using Easy Configuration** to create the RAID set.

6.2.2 Adding or viewing a RAID configuration

You can add a new RAID configuration or view an existing configuration using the **View/Add Configuration** command.

Adding a new RAID configuration

To add a new RAID configuration:

1. From the **Management Menu**, select **Configure > View/Add Configuration**, and then press <Enter>.

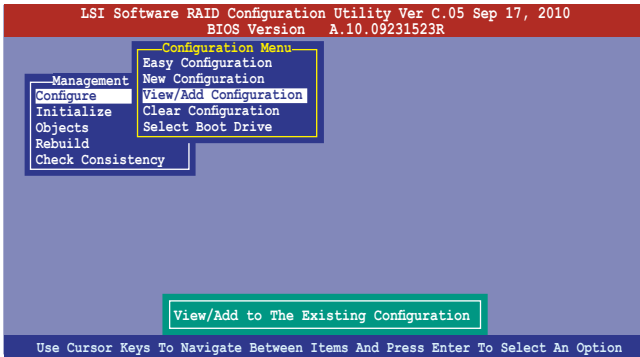

2. The **ARRAY SELECTION MENU** displays the available drives connected to the SATA ports. Select the drive(s) you want to include in the RAID set, then press <Space>. When selected, the drive indicator changes from **READY** to **ONLIN A[X]-[Y]**, where X is the array number, and Y is the drive number.

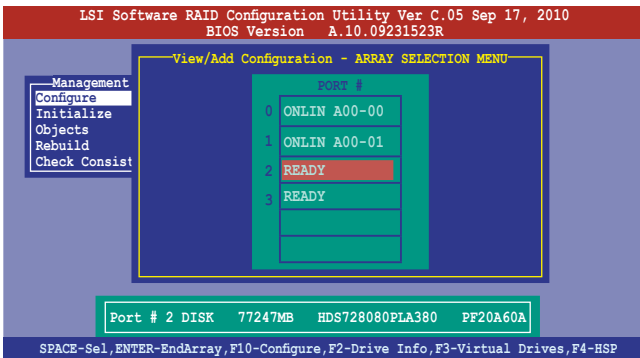

The information of the selected hard disk drive displays at the bottom of the screen.

3. Follow step 3 to 12 of section **6.2.1 Creating a RAID set: Using Easy Configuration** to add a new RAID set.

6.2.3 Initializing the virtual drives

After creating the RAID set(s), you must initialize the virtual drives. You may initialize the virtual drives of a RAID set(s) using the **Initialize** or **Objects** command on the **Management Menu**.

Using the Initialize command

To initialize the virtual drive using the Initialize command

1. From the **Management Menu**, select **Initialize**, and then press <Enter>.

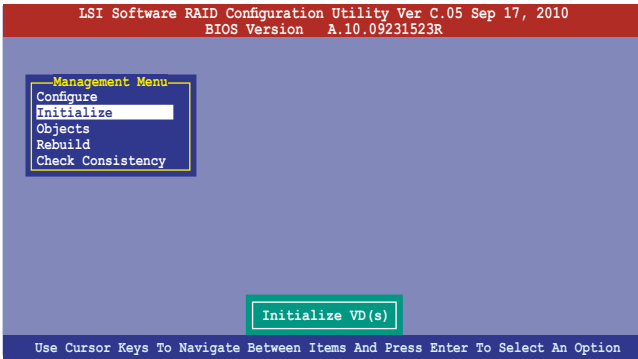

2. The screen displays the available RAID set(s) and prompts you to select the virtual drive to initialize. Use the arrow keys to select the virtual drive from the **Virtual Drive** selection, and then press <Space>.

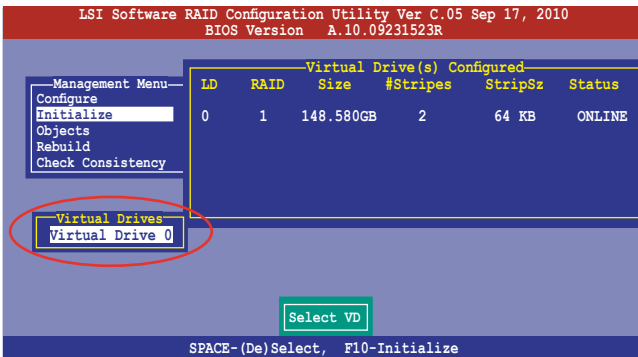

3. Press <F10> to start initialization. When prompted, select **Yes** from the **Initialize?** dialog box, and then press <Enter>.

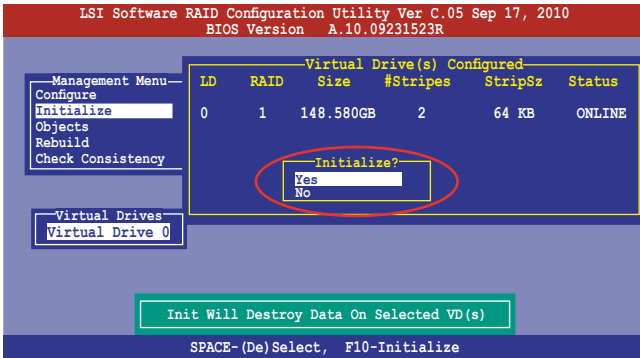

Initializing a virtual drive erases all data on the drive.

4. A progress bar appears on screen. If desired, press <Esc> to abort initialization. When initialization is completed, press <Esc>.

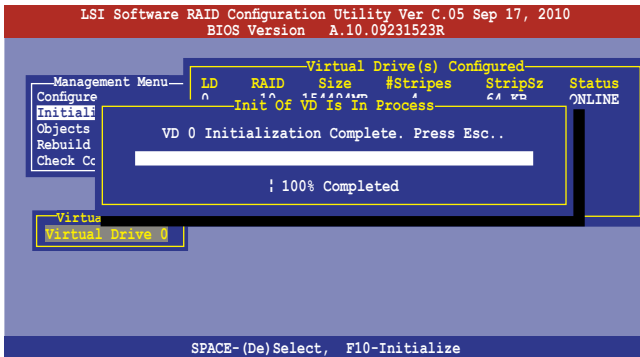

Using the Objects command

To initialize the virtual drives using the **Objects** command

1. From the **Management Menu**, select **Objects > Virtual Drive**, and then press <Enter>.

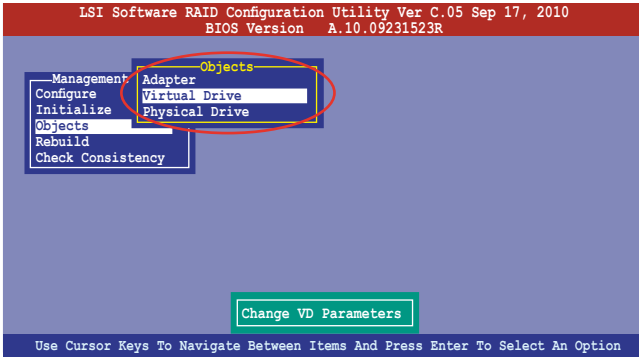

2. Select the virtual drive to initialize from the **Virtual Drives** sub-menu, and then press <Enter>.

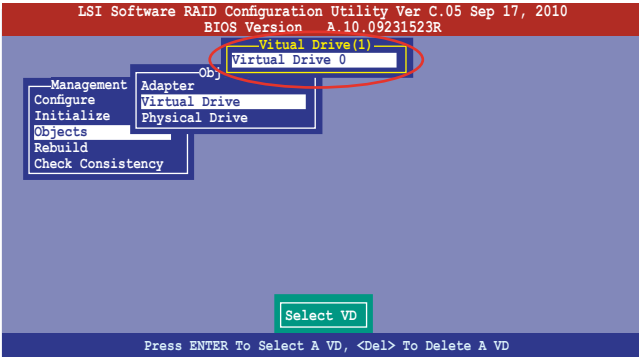

3. Select **Initialize** from the pop-up menu, and then press <Enter> to start initialization.

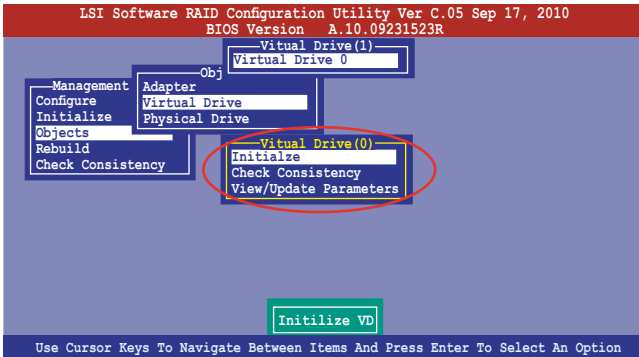

4. When prompted, press the <Space> to select **Yes** from the **Initialize?** dialog box, and then press <Enter>.

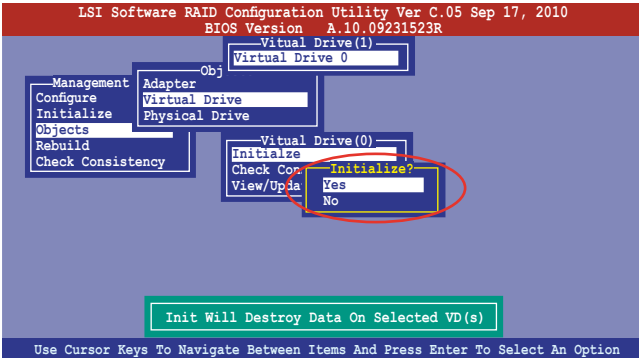

5. A progress bar appears on screen. If desired, press <Esc> to abort initialization. When initialization is completed, press <Esc>.

6.2.4 Rebuilding failed drives

You can manually rebuild failed hard disk drives using the **Rebuild** command in the **Management Menu**.

To rebuild a failed hard disk drive

1. From the **Management Menu**, select **Rebuild**, and then press <Enter>.

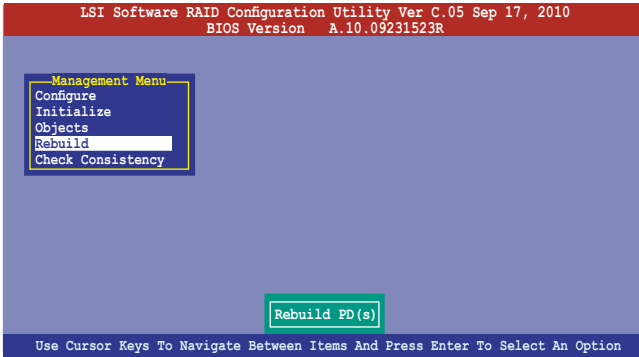

2. The **PHYSICAL DRIVES SELECTION MENU** displays the available drives connected to the SATA ports. Select the drive you want to rebuild, and then press <Space>.

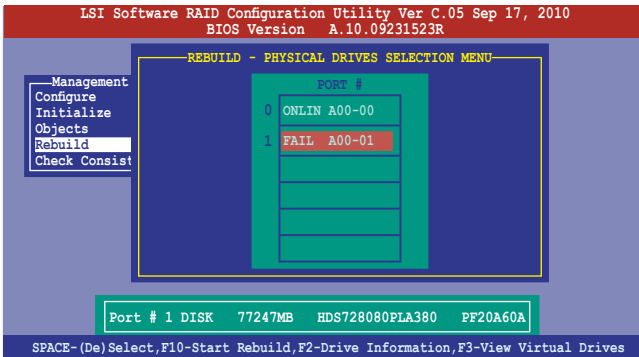

3. After selecting the drive to rebuild, press <F10>. When prompted, press <Y> to rebuild the drive.

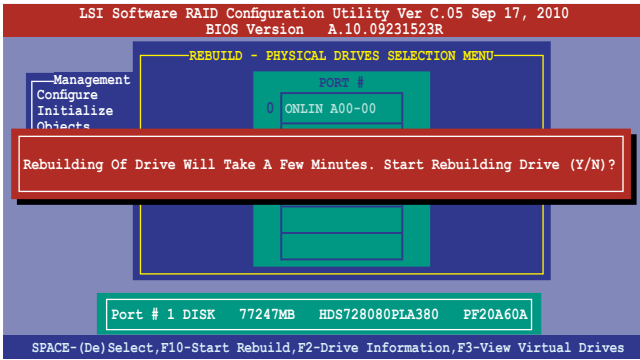

4. When rebuild is complete, press any key to continue.

6.2.5 Checking the drives for data consistency

You can check and verify the accuracy of data redundancy in the selected virtual drive. The utility can automatically detect and/or detect and correct any differences in data redundancy depending on the selected option in the **Objects > Adapter** menu.



The **Check Consistency** command is available only for virtual drives included in a RAID 1 or RAID 10 set.

Using the Check Consistency Command

To check data consistency using the **Check Consistency** command

1. From the **Management Menu**, select **Check Consistency**, and then press <Enter>.

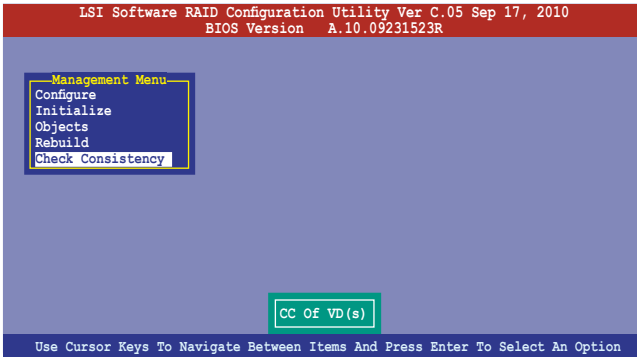

2. The screen displays the available RAID set(s) and prompts you to select the virtual drive to check. Press <Space> to select the virtual drive from the **Virtual Drive** sub-menu, and then press <F10>.

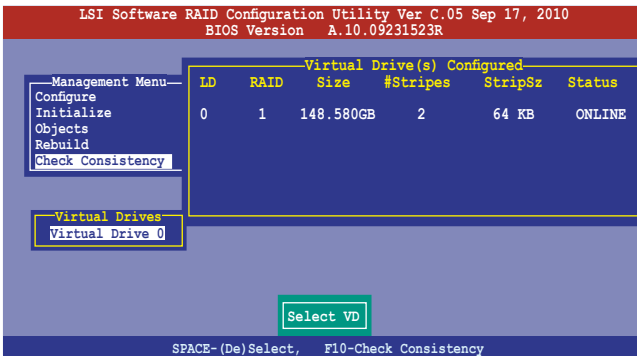

- When prompted, use the arrow keys to select **Yes** from the **Consistency Check?** dialog box, and then press <Enter>.

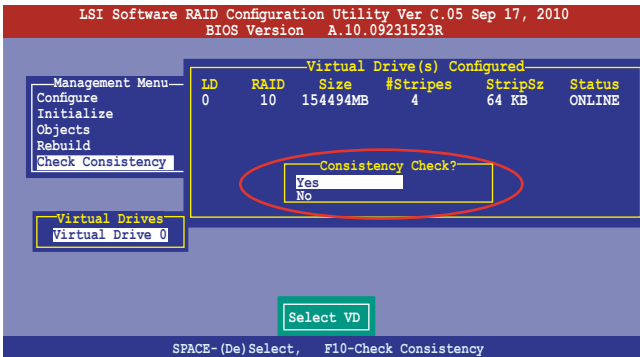

A progress bar appears on screen.

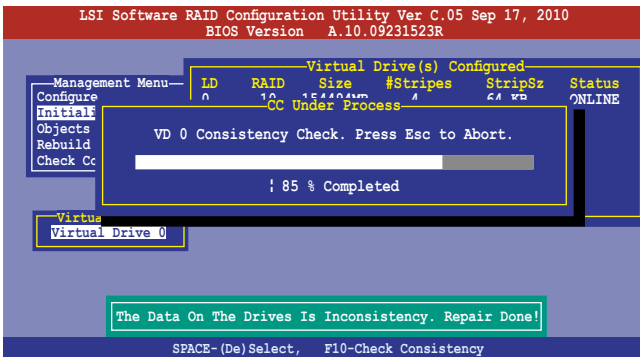

- While checking the disk consistency, press <Esc> to display the following options.
 - Stop** - Stops the consistency check. The utility stores the percentage of disk checked, and when you restart checking, it continues from the last percentage completed rather than from zero percent.
 - Continue** - Continues the consistency check.
 - Abort** - Aborts the consistency check. When you restart checking, it continues from zero percent.
- When checking is complete, press any key to continue.

Using the Objects command

To check data consistency using the **Objects** command

1. From the **Management Menu**, select **Objects**, and then select **Virtual Drive** from the sub-menu.
2. Use the arrow keys to select the virtual drive you want to check, and then press <Enter>.
3. Select **Check Consistency** from the pop-up menu, and then press <Enter>.
4. When prompted, use the arrow keys to select **Yes** from the dialog box to check the drive.
5. When checking is complete, press any key to continue.

6.2.6 Deleting a RAID configuration

To delete a RAID configuration

1. From the **Management Menu**, select **Configure > Clear Configuration**, and then press <Enter>.

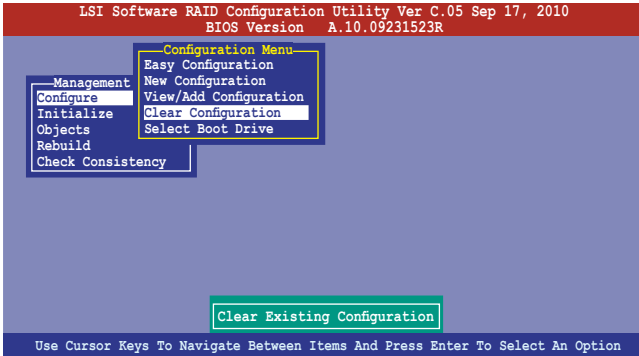

2. When prompted, use the arrow keys to select **Yes** from the **Clear Configuration?** dialog box, and then press <Enter>.

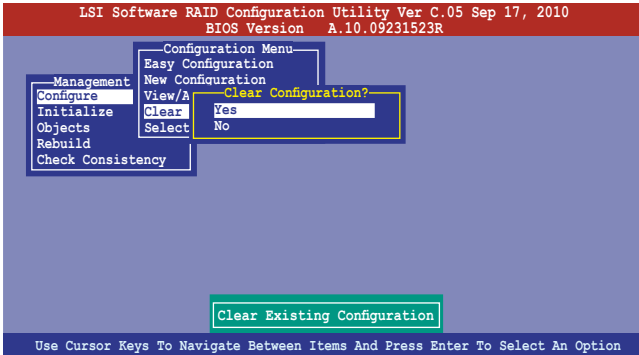

The utility clears all the current array(s).

3. Press any key to continue.

6.2.7 Selecting the boot drive from a RAID set

You must have created a new RAID configuration before you can select the boot drive from a RAID set. See section 6.2.1 **Creating a RAID set: Using New Configuration** for details.

To select the boot drive from a RAID set

1. From the **Management Menu**, select **Configure > Select Boot Drive**, and then press <Enter>.

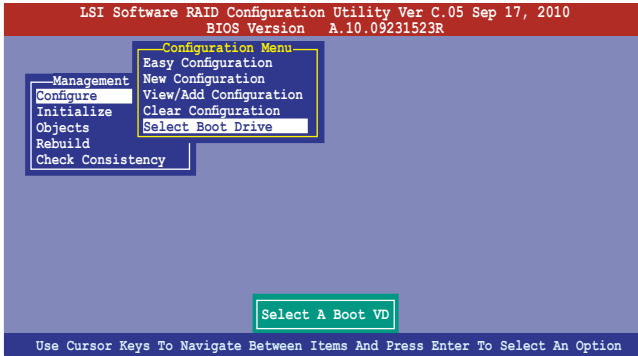

2. When prompted, use the arrow keys to select the bootable virtual drive from the list, then press <Enter>.

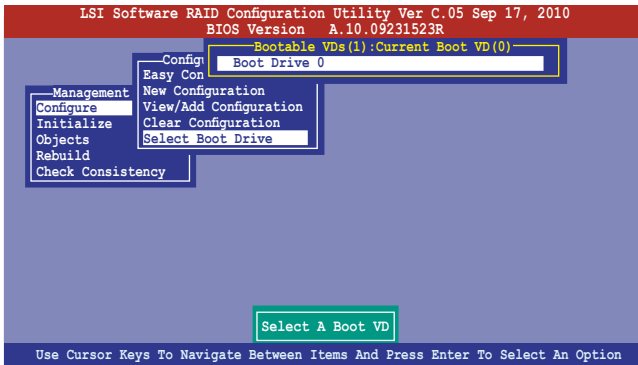

3. The virtual drive is selected as boot drive. Press any key to continue.

6.2.8 Enabling WriteCache

You may manually enable the RAID controller's WriteCache option after creating a RAID set to improve the data transmission performance.



When you enable WriteCache, you may lose data when a power interruption occurs while transmitting or exchanging data among the drives.



The WriteCache function is recommended for RAID 1 and RAID 10 sets.

To enable WriteCache

1. From the **Management Menu**, select **Objects > Adapter**, select an existing adapter, and then press <Enter> to display the adapter properties.
2. Select **Disk WC**, and then press <Enter> to turn on the option.

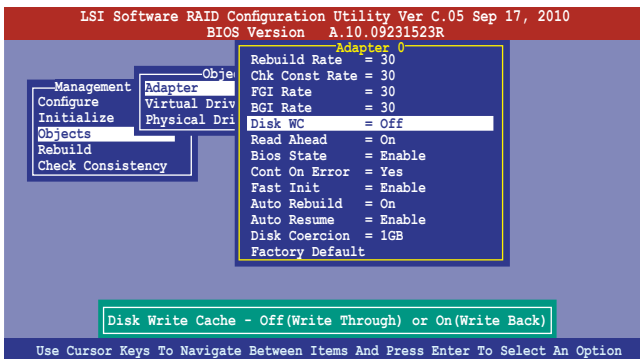

3. From the **Management Menu**, select **Objects > Virtual Drive**, select an existing adapter and press <Enter>. Select **View/Update Parameters** and press <Enter> to display the adapter properties.
4. Select **Disk WC**, and then press <Enter> to turn on the option.

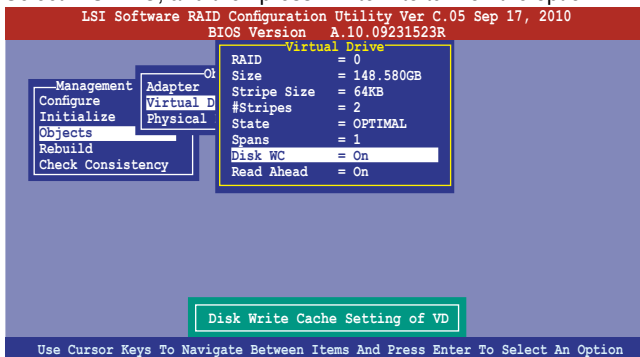

5. When finished, press any key to continue.

6.3 Intel® Rapid Storage Technology Option ROM Utility

The Intel® Rapid Storage Technology Option ROM utility allows you to create RAID 0, RAID 1, RAID 10 (RAID 1+0), and RAID 5 set(s) from Serial ATA hard disk drives that are connected to the Serial ATA connectors supported by the Southbridge.

To enter the Intel® Rapid Storage Technology option ROM utility:

1. Install all the Serial ATA hard disk drives.
2. Turn on the system.
3. During POST, press <Ctrl+I> to display the utility main menu.

```
Intel(R) Rapid Storage Technology - Option ROM - 10.1.0.1008
Copyright(C) 2003-10 Intel Corporation. All Rights Reserved.

----- [ MAIN MENU ] -----
  1. Create RAID Volume
  2. Delete RAID Volume
  3. Reset Disks to Non-RAID
  4. Recovery Volume Options
  5. Exit

----- [ DISK/VOLUME INFORMATION ] -----

RAID Volumes:
None defined.
* = Data is Encrypted

Physical Devices:
Port Drive Model      Serial #      Size      Type/Status(Vol ID)
0  ST3160812AS        9LS0BJA4     149.0GB   Non-RAID Disk
1  ST3160812AS        9LS0F4HL     149.0GB   Non-RAID Disk
2  ST3160812AS        3LS0JYL8     149.0GB   Non-RAID Disk
3  ST3160812AS        9LS0BJ5H     149.0GB   Non-RAID Disk

[↑↓]-Select      [ESC]-Exit      [ENTER]-Select Menu
```

The navigation keys at the bottom of the screen allow you to move through the menus and select the menu options.



The RAID BIOS setup screens shown in this section are for reference only and may not exactly match the items on your screen.

6.3.1 Creating a RAID set

To create a RAID set:

1. From the utility main menu, select **1. Create RAID Volume** and press <Enter>. The following screen appears.

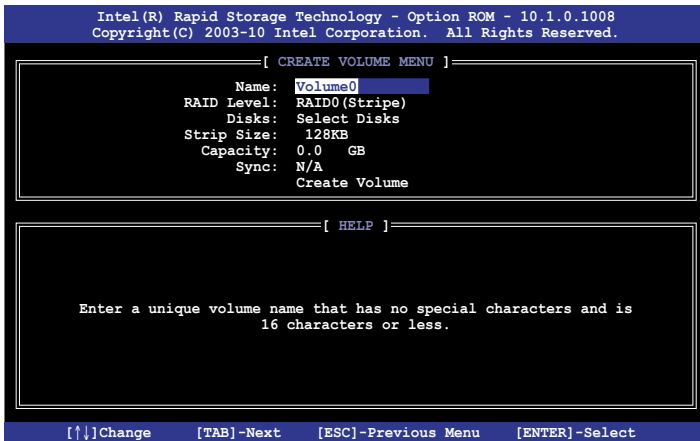

2. Enter a name for the RAID set and press <Enter>.
3. When the **RAID Level** item is selected, press the up/down arrow keys to select a RAID level to create, and then press <Enter>.
4. When the **Disks** item is selected, press <Enter> to select the hard disk drives you want to include in the RAID set. The **SELECT DISKS** screen appears.

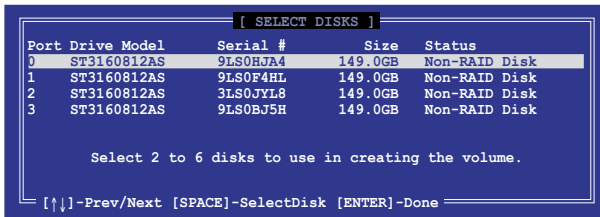

5. Use the up/down arrow keys to select a drive, and then press <Space> to select. A small triangle marks the selected drive. Press <Enter> after completing your selection.

- Use the up/down arrow keys to select the stripe size for the RAID array (for RAID 0, 10 and 5 only), and then press <Enter>. The available stripe size values range from 4 KB to 128 KB. The following are typical values:
RAID 0: 128KB
RAID 10: 64KB
RAID 5: 64KB



We recommend a lower stripe size for server systems, and a higher stripe size for multimedia computer systems used mainly for audio and video editing.

- When the **Capacity** item is selected, enter the RAID volume capacity that you want and press <Enter>. The default value indicates the maximum allowed capacity.
- When the **Create Volume** item is selected, press <Enter>. The following warning message appears.



- Press <Y> to create the RAID volume and return to the main menu, or <N> to go back to the **CREATE VOLUME** menu.

6.3.2 Creating a Recovery set

To create a recovery set:

- From the utility main menu, select **1. Create RAID Volume** and press <Enter>. The following screen appears.

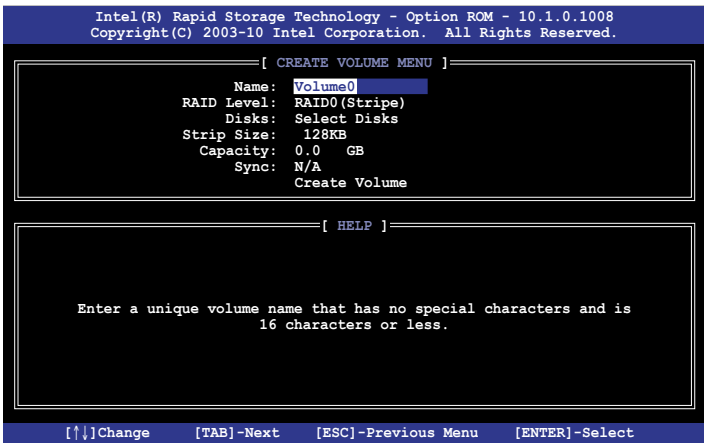

2. Enter a name for the recovery set and press <Enter>.
3. When the **RAID Level** item is selected, press the up/down arrow keys to select **Recovery**, and then press <Enter>.
4. When the **Disks** item is selected, press <Enter> to select the hard disk drives you want to include in the recovery set. The **SELECT DISKS** screen appears.

```

[ SELECT DISKS ]
Port Drive Model      Serial #      Size      Status
0  ST3160812AS        9LS0HJA4    149.0GB  Non-RAID Disk
1  ST3160812AS        9LS0F4HL    149.0GB  Non-RAID Disk
2  ST3160812AS        3LS0JYL8    149.0GB  Non-RAID Disk
3  ST3160812AS        9LS0BJ5H    149.0GB  Non-RAID Disk

Select 1 Master and 1 Recovery disk to create volume.

[↑↓]-Prev/Next [TAB]- (M)aster [SPACE]- (R)ecovery [ENTER]-Done

```

5. Use the up/down arrow keys to select a drive, press <TAB> to select a Master disk, and then press <SPACE> to select a Recovery disk. A small triangle marks the selected drive. Press <Enter> after completing your selection.
6. When the **Sync** item is selected, use the up/down arrow keys to select a sync option that you want and press <Enter>.
7. When the **Create Volume** item is selected, press <Enter>. The following warning message appears.

```

WARNING: ALL DATA ON SELECTED DISKS WILL BE LOST.
Are you sure you want to create this volume? (Y/N):

```

8. Press <Y> to create the recovery set and return to the main menu, or <N> to go back to the **CREATE VOLUME** menu.



If a recovery set is created, you cannot add more RAID sets even when you have more non-RAID disks installed in your system.

6.3.3 Deleting a RAID set



Take caution when deleting a RAID set. You will lose all data on the hard disk drives when you delete a RAID set.

To delete a RAID set:

1. From the utility main menu, select **2. Delete RAID Volume** and press <Enter>. The following screen appears.

```
Intel(R) Rapid Storage Technology - Option ROM - 10.1.0.1008
Copyright(C) 2003-10 Intel Corporation. All Rights Reserved.

-----[ DELETE VOLUME MENU ]-----
Name      Level      Drives   Capacity  Status   Bootable
Volume0   RAID0(Stripe)  2        298.0GB   Normal   Yes

-----[ HELP ]-----

Deleting a volume will reset the disks to non-RAID.
WARNING: ALL DISK DATA WILL BE DELETED.
(This does not apply to Recovery volumes)

[↑↓]-Select      [ESC]-Previous Menu  [DEL]-Delete Volume
```

2. Use the up/down arrow keys to select the RAID set you want to delete, and then press . The following warning message appears.

```
[ DELETE VOLUME VERIFICATION ]

ALL DATA IN THE VOLUME WILL BE LOST!
(This does not apply to Recovery volumes)

Are you sure you want to delete volume "Volume0"? (Y/N) :
```

3. Press <Y> to delete the RAID set and return to the utility main menu, or press <N> to return to the **DELETE VOLUME** menu.

6.3.4 Resetting disks to Non-RAID



Take caution before you reset a RAID volume hard disk drive to non-RAID. Resetting a RAID volume hard disk drive deletes all internal RAID structure on the drive.

To reset a RAID set hard disk drive:

1. From the utility main menu, select **3. Reset Disks to Non-RAID** and press <Enter>. The following screen appears.

```
[ RESET RAID DATA ]

Resetting RAID disk will remove its RAID structures
and revert it to a non-RAID disk.

WARNING: Resetting a disk causes all data on the disk to be lost.
(This does not apply to Recovery volumes)

Port Drive Model      Serial #      Size   Status
0  ST3160812AS        9LS0HJA4    149.0GB Member Disk
1  ST3160812AS        9LS0F4HL    149.0GB Member Disk

Select the disks that should be reset.

[↑↓]-Previous/Next [SPACE]-Selects [ENTER]-Selection Complete
```

2. Use the up/down arrow keys to select the RAID set drive(s) you want to reset, and then press <Space> to select.
3. Press <Enter> to reset the RAID set drive(s). A confirmation message appears.
4. Press <Y> to reset the drive(s) or press <N> to return to the utility main menu.

6.3.5 Recovery Volume Options

If you have created a recovery set, you can configure more recovery set options following the descriptions in the section.



See section 6.3.2 **Creating a Recovery set** to create a recovery set before continue.

To configure a recovery set:

1. From the utility main menu, select **4. Recovery Volume Options** and press <Enter>. The following screen appears.

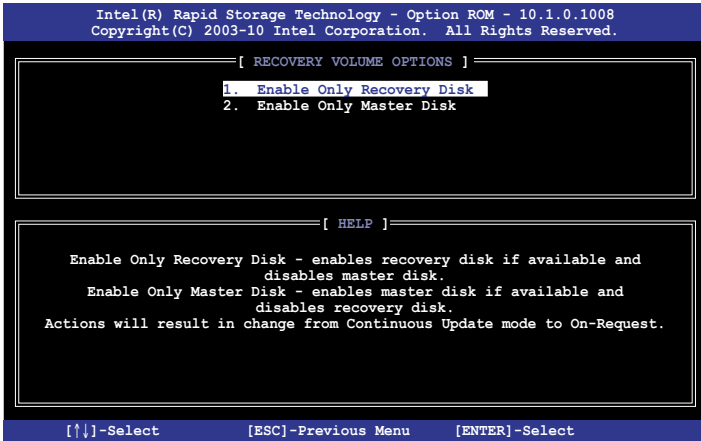

2. Use the up/down arrow keys to select the option you want, and then press <ENTER>. The **SELECT RECOVERY VOLUME** screen appears.

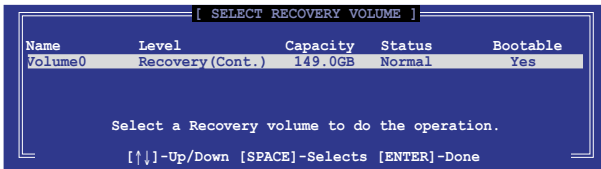

3. Use the up/down arrow keys to select a drive, and then press <Space> to select. A small triangle marks the selected drive. Press <Enter> after completing your selection and return to the utility main menu.

6.3.6 Exiting the Intel® Rapid Storage Technology utility

To exit the utility:

1. From the utility main menu, select **5. Exit**, and then press <Enter>. The following warning message appears.



2. Press <Y> to exit or press <N> to return to the utility main menu.

6.3.7 Rebuilding the RAID



This option is only for the RAID 1 set.

Rebuilding the RAID with other non-RAID disk

If any of the SATA hard disk drives included in the RAID 1 array failed, the system displays the status of the RAID volume as “**Degraded**” during POST. You can rebuild the RAID array with other installed non-RAID disks.

To rebuild the RAID with other non-RAID disk:

1. At the prompt, press <Ctrl> + <I> to enter the Intel Rapid Storage Technology option ROM utility.
2. If there is a non-RAID SATA Hard Disk available, the utility will prompt to rebuild the RAID. Press <Enter>, and then use up/down arrow keys to select the destination disk or press <ESC> to exit.

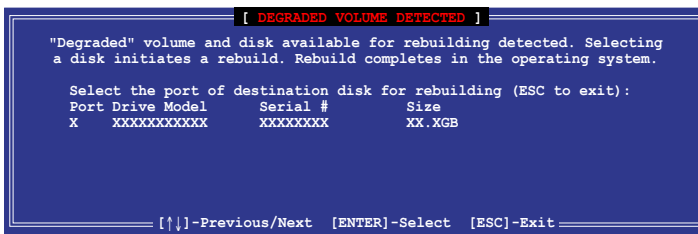

Select a destination disk with the same size as the original hard disk.

- The utility immediately starts rebuilding after the disk is selected. The status of the degraded RAID volume is changed to **“Rebuild”**.

```

Intel(R) Rapid Storage Technology - Option ROM - 10.1.0.1008
Copyright(C) 2003-10 Intel Corporation. All Rights Reserved.

[ MAIN MENU ]
1. Create RAID Volume
2. Delete RAID Volume
3. Reset Disks to Non-RAID
4. Recovery Volume Options
5. Exit

[ DISK/VOLUME INFORMATION ]

RAID Volumes:
ID Name Level Strip Size Status Bootable
0 Volume0 RAID1(Mirror) N/A 149.0GB Rebuild Yes

Physical Devices:
Port Drive Model Serial # Size Type/Status(Vol ID)
1 ST3160812AS 9LS0F4HL 149.0GB Member Disk(0)
2 ST3160812AS 3LS0JYL8 149.0GB Member Disk(0)

Volumes with "Rebuild" status will be rebuilt within the operating system.

[↑↓]-Select [ESC]-Exit [ENTER]-Select Menu

```

- Exit Intel Rapid Storage Technology and reboot the system.
- Select **Start > Programs > Intel Rapid Storage > Intel Rapid Storage Console** or click the **Intel Rapid Storage Technology** tray icon to load the Intel Rapid Storage Manager utility.
- From the **View** menu, select **Advanced Mode** to display the details of the Intel Rapid Storage Console.
- From the **Volumes view** option, select **RAID volume** to view the rebuilding status. When finished, the status is changed to **“Normal”**.

Rebuilding the RAID with a new hard disk

If any of the SATA hard disk drives included in the RAID array failed, the system displays the status of the RAID volume as **“Degraded”** during POST. You may replace the disk drive and rebuild the RAID array.

To rebuild the RAID with a new hard disk:

- Remove the failed SATA hard disk and install a new SATA hard disk of the same specification into the same SATA Port.



Select a destination disk with the same size as the original hard disk.

- Reboot the system and then follow the steps in section **Rebuilding the RAID with other non-RAID disk**.

6.3.8 Setting the Boot array in the BIOS Setup Utility

You can set the boot priority sequence in the BIOS for your RAID arrays when creating multi-RAID using the Intel® Rapid Storage Technology.

To set the boot array in the BIOS:



Set at least one of the arrays bootable to boot from the hard disk.

1. Reboot the system and press to enter the BIOS setup utility during POST.
2. Go to the **Boot** menu and select the boot option priority.
3. Use up/down arrow keys to select the boot priority and press <Enter>. See section **5.8 Boot menu** for details.
4. From the **Exit** menu, select **Save Changes & Exit**, then press <Enter>.
5. When the confirmation window appears, select **Yes**, then press <Enter>.

Chapter 7

This chapter provides instructions for installing the necessary drivers for different system components.

Driver installation

7.1 RAID driver installation

After creating the RAID sets for your server system, you are now ready to install an operating system to the independent hard disk drive or bootable array. This part provides instructions on how to install the RAID controller drivers during OS installation.

7.1.1 Creating a RAID driver disk



The system does not include a floppy drive. You have to use a USB floppy drive when creating a SATA RAID driver disk.



If you have created RAID sets with the LSI Software RAID configuration utility, the boot priority of the SATA optical disk drive has to be manually adjusted. Otherwise, the system will not boot from the connected SATA ODD.

A floppy disk with the RAID driver is required when installing Windows® or Red Hat® Enterprise operating system on a hard disk drive that is included in a RAID set. You can create a RAID driver disk in DOS (using the Makedisk application in the support DVD).

To create a RAID driver disk in DOS environment

1. Place the motherboard support DVD in the optical drive.
2. Restart the computer, and then enter the BIOS Setup.
3. Select the optical drive as the first boot priority to boot from the support DVD. Save your changes, and then exit the BIOS Setup.
4. Restart the computer. The Makedisk menu appears.

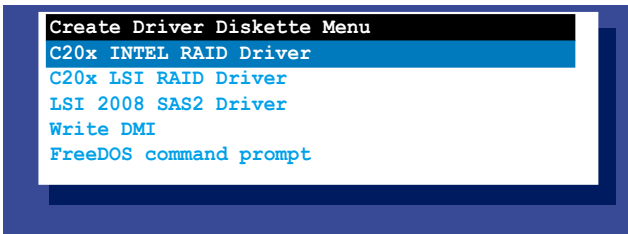

5. Use the arrow keys to select the type of RAID driver disk you want to create and press <Enter> to enter the sub-menu.

C20x INTEL RAID Driver

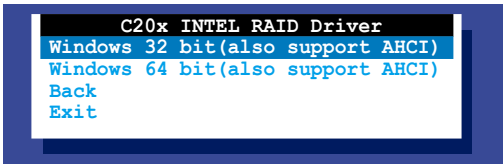

C20x LSI RAID Driver

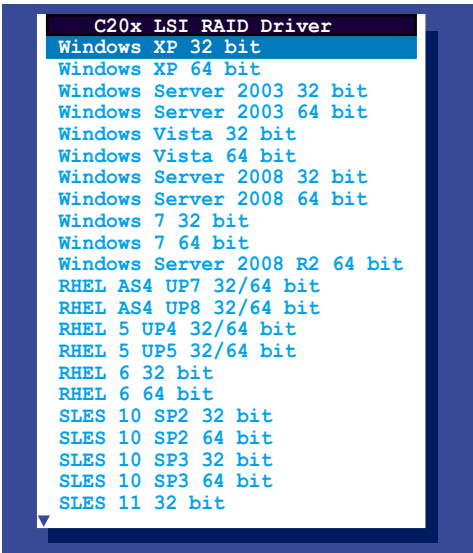

6. Locate the RAID driver and place a blank, high-density floppy disk to the floppy disk drive.
7. Press <Enter>.
8. Follow screen instructions to create the driver disk.

To create a RAID driver disk in Windows® environment

1. Start Windows®.
2. Place the motherboard support DVD into the optical drive.
3. Go to the **Make disk** menu, and then select the type of RAID driver disk you want to create.
4. Insert a floppy disk into the USB floppy disk drive.
5. Follow succeeding screen instructions to complete the process.



Write-protect the floppy disk to avoid computer virus infection.

To create a RAID driver disk in Red Hat® Enterprise Linux server environment

1. Insert a blank formatted high-density floppy disk to the USB floppy disk drive.
2. Type `dd if=xxx.img of=/dev/fd0` to decompress the file into the floppy disk from the following path in the support DVD:

For LSI MegaRAID Driver

\\Drivers\C20x LSI RAID\Driver\makedisk\Linux

3. Eject the floppy disk.

7.1.2 Installing the RAID controller driver

Windows® Server OS

During Windows® Server OS installation

To install the RAID controller driver when installing Windows® Server OS:

1. Boot the computer using the Windows® Server installation DVD. The Windows® Server OS Setup starts.

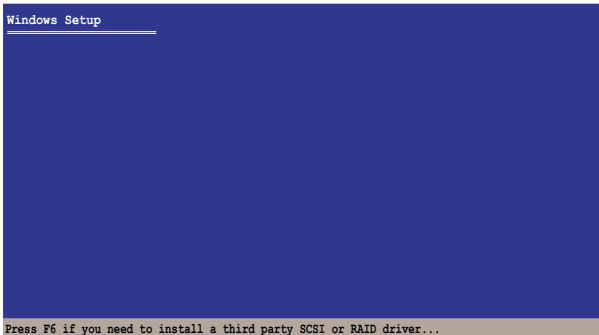

2. Press <F6> when the message "Press F6 if you need to install a third party SCSI or RAID driver..." appears at the bottom of the screen.
3. When prompted, press <S> to specify an additional device.

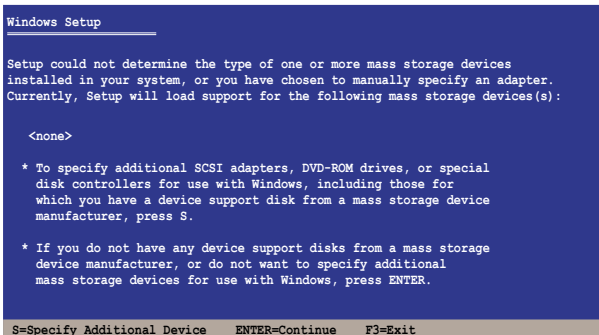

4. Insert the RAID driver disk you created earlier to the floppy disk drive, then press <Enter>.

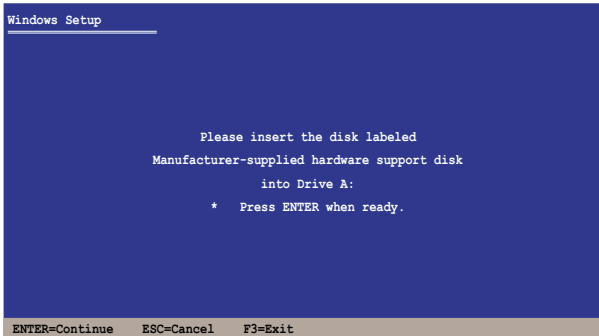

5. Select the RAID controller driver you need from the list, then press <Enter>.
6. The Windows® Setup loads the RAID controller drivers from the RAID driver disk. When prompted, press <Enter> to continue installation.
7. Setup then proceeds with the OS installation. Follow screen instructions to continue.

To an existing Windows® Server OS

To install the RAID controller driver on an existing Windows® Server OS

1. Restart the computer, and then log in with **Administrator** privileges.
2. Windows® automatically detects the RAID controller and displays a **New Hardware Found** window. Click **Cancel**.
3. Right-click the **My Computer** icon on the Windows® desktop, and then select **Properties** from the menu.
4. Click the **Hardware** tab, and then click the **Device Manager** button to display the list of devices installed in the system.
5. Right-click the **RAID controller** item, then select **Properties**.
6. Click the **Driver** tab, and then click the **Update Driver** button.
7. The **Upgrade Device Driver Wizard** window appears. Click **Next**.
8. Insert the RAID driver disk you created earlier to the floppy disk drive.
9. Select the option **Install the software automatically (Recommended)**, and then click **Next**.
10. The wizard searches the RAID controller drivers. When found, click **Next** to install the drivers.
11. Click **Finish** after the driver installation is done.

To verify the RAID controller driver installation:

1. Right-click the **My Computer** icon on the Windows® desktop, and then select **Properties** from the menu.
2. Click the **Hardware** tab, and then click the **Device Manager** button.
3. Click the “+” sign before the item **SCSI and RAID controllers**, and then the **Intel(R) ICH8R/ICH9R/ICH10R/DO/PCH SATA RAID Controller** item should appear.

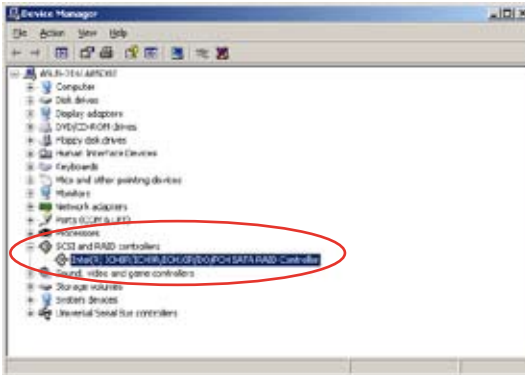

The screen differs based on the controller.

4. Right-click the **RAID controller** driver item, and then select **Properties** from the menu.
5. Click the **Driver** tab, and then click the **Driver Details** button to display the RAID controller drivers.
6. Click **OK** when finished.

Red Hat® Enterprise Linux OS 5.0

To install the RAID controller driver when installing Red Hat® Enterprise OS:

1. Boot the system from the Red Hat® OS installation CD.
2. At the `boot:`, type `linux dd`.
3. Press `<Enter>`.

```
- To install or upgrade in graphical mode, press the <ENTER> key.  
- To install or upgrade in text mode, type: linux text <ENTER>.  
- Use the function keys listed below for more information.  
[F1-Main] [F2-Options] [F3-General] [F4-Kernel] [F5-Rescue]  
boot: linux dd
```

4. Select **Yes** using the `<Tab>` key when asked if you have the driver disk, then press `<Enter>`.

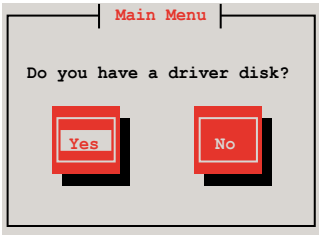

5. Insert the Red Hat® Enterprise RAID driver disk to the USB floppy disk drive, select **OK**, then press `<Enter>`.

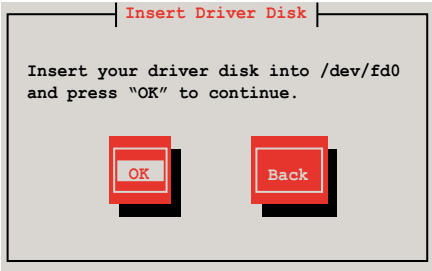

The drivers for the RAID card are installed to the system.

- When asked if you will load additional RAID controller drivers, select **No**, then press <Enter>.

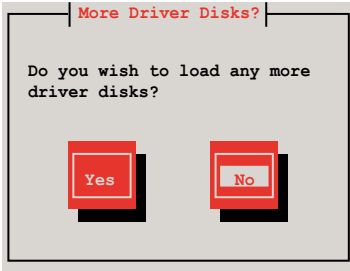

- Follow the onscreen instructions to finish the OS installation.

SUSE Linux 11 OS

To install the RAID controller driver when installing SUSE Linux Enterprise Server OS:

1. Boot the system from the SUSE OS installation CD.
2. Use the arrow keys to select **Installation** from the **Boot Options** menu.

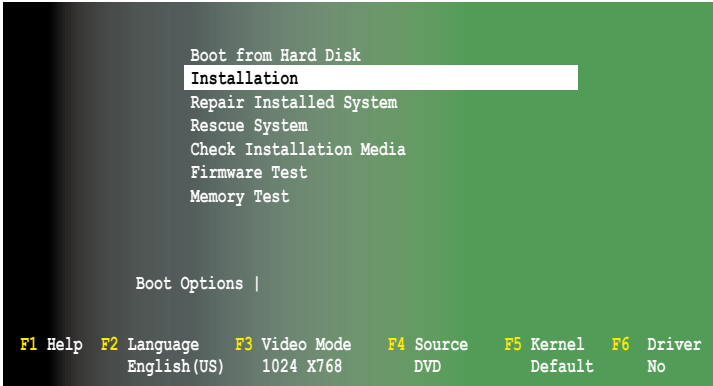

3. Press <F6>, then select **Yes** from the menu. Press <Enter>.

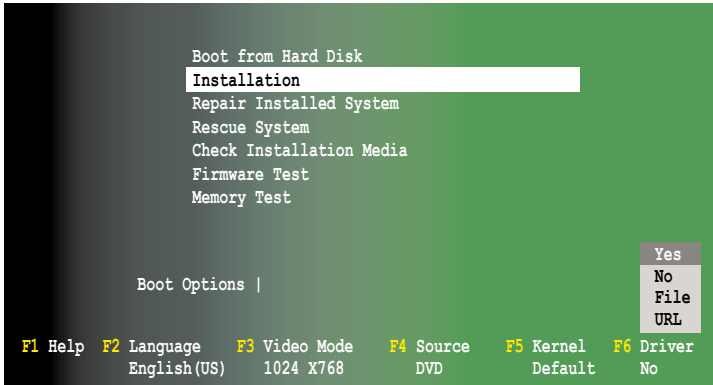

4. Insert the RAID driver disk to the floppy disk drive. Type the command **acpi=off apic=bigsm brokenmodules=ahci** in **Boot Options** field, and press <Enter>.

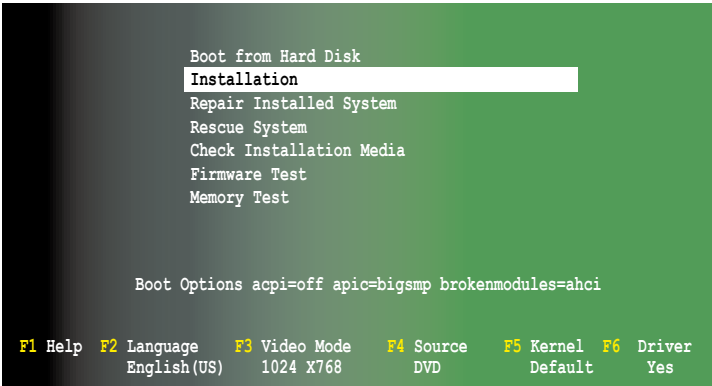

5. When below screen appears, select the USB floppy disk drive (sda) as the driver update medium. Select **OK**, then press <Enter>.

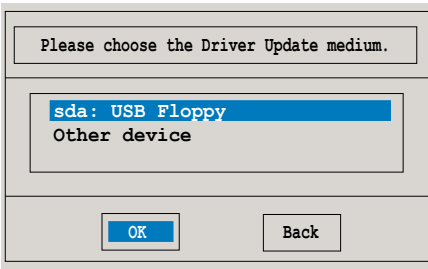

- The drivers for the RAID controller are installed to the system as shown below.

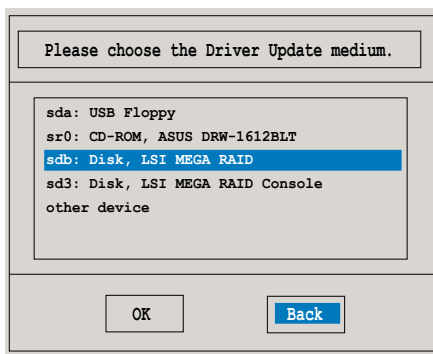

- Select **Back** and follow the onscreen instructions to finish the installation.

7.2 Intel® chipset device software installation

This section provides the instructions on how to install the Intel® chipset device software on the system.

You need to manually install the Intel® chipset device software on a Windows operating system.

To install the Intel® chipset device software:

1. Restart the computer, and then log on with **Administrator** privileges.
2. Insert the motherboard/system support DVD to the optical drive. The support DVD automatically displays the **Drivers** menu if Autorun is enabled in your computer.

If Autorun is NOT enabled in your computer, browse the contents of the support DVD to locate the file **ASSETUP.EXE** from the **BIN** folder. Double-click the **ASSETUP.EXE** to run the support DVD.

3. Click the item **Intel Chipset Device Software** from the menu.



4. The **Intel(R) Chipset Device Software** window appears. Click **Next** to start installation.



5. Select **Yes** to accept the terms of the **License Agreement** and continue the process.



6. Read the **Readme File Information** and press **Next** to continue the installation.



7. After completing the installation, click **Finish** to complete the setup process.



7.3 LAN driver installation

This section provides the instructions on how to install the Intel® Gigabit LAN controller drivers on the system.

You need to manually install the LAN controller driver on a Windows® operating system.

To install the LAN controller drivers:

1. Restart the computer, and then log on with **Administrator** privileges.
2. Insert the motherboard/system support DVD to the optical drive. The support DVD automatically displays the **Drivers** menu if Autorun is enabled in your computer.



- Windows® automatically detects the LAN controllers and displays a New Hardware Found window. Click **Cancel** to close this window.
- If Autorun is NOT enabled in your computer, browse the contents of the support DVD to locate the file **ASSETUP.EXE** from the **BIN** folder. Double-click the **ASSETUP.EXE** to run the DVD.

3. Click the **Intel® PRO/1000 Gigabit Adapters Driver** to begin installation.



- Click **Next** when the **Intel(R) Network Connections–InstallShield Wizard** window appears.



- Toggle **I accept the terms in the license agreement** and click **Next** to continue.



- Click the **Intel(R) PROSet for Windows Device Manager** box, and then click **Next** to start the installation.

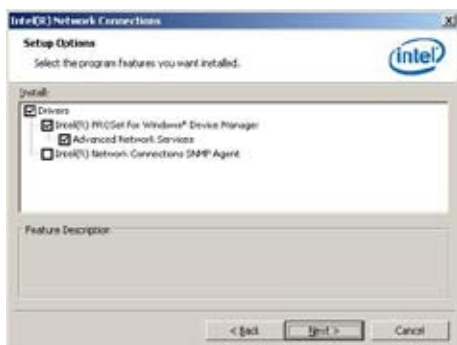

7. Follow the screen instructions to complete installation.

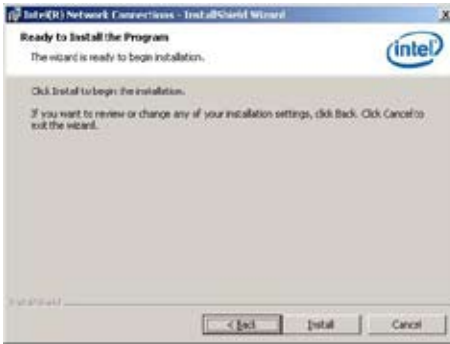

8. When finished, press **Finish** to continue.



7.4 VGA driver installation

This section provides the instructions on how to install the ASPEED Video Graphics Adapter (VGA) driver.

You need to manually install the ASPEED VGA driver on a Windows® operating system.

To install the ASPEED VGA driver:

1. Restart the computer, and then log on with **Administrator** privileges.
2. Insert the motherboard/system support DVD to the optical drive. The support DVD automatically displays the **Drivers** menu if Autorun is enabled in your computer.



If Autorun is NOT enabled in your computer, browse the contents of the support DVD to locate the file **ASSETUP.EXE** from the **BIN** folder. Double-click the **ASSETUP.EXE** to run the support DVD.

3. Click the **ASPEED AST2050 Display Driver** to begin installation.



4. Click **Next** to start the installation.



5. Toggle **I accept the terms in the license agreement** and click **Next** to continue.



6. Enter the user information and click **Next** to continue.

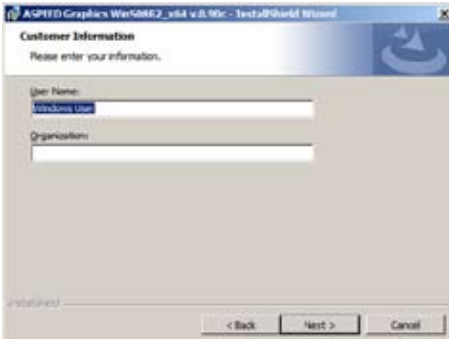

7. Select a setup type and click **Next** to continue.



8. Click **Install** to start driver installation.

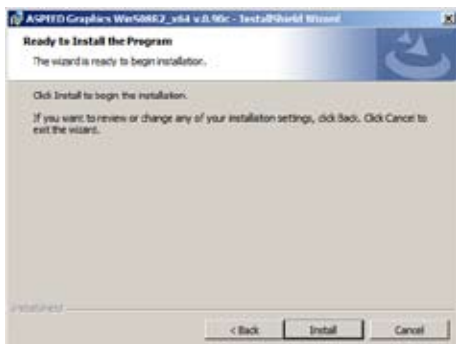

9. When the installation completes, click **Finish** to restart your computer before using the program.



7.5 Management applications and utilities installation

The support DVD that came with the motherboard package contains the drivers, management applications, and utilities that you can install to avail all motherboard features.



The contents of the support DVD are subject to change at any time without notice. Visit the ASUS website (www.asus.com) for updates.

7.5.1 Running the support DVD

Place the support DVD to the optical drive. The DVD automatically displays the Drivers menu if Autorun is enabled in your computer.



If Autorun is NOT enabled in your computer, browse the contents of the support DVD to locate the file ASSETUP.EXE from the BIN folder. Double-click the ASSETUP.EXE to run the DVD.

7.5.2 Drivers menu

The Drivers menu shows the available device drivers if the system detects installed devices. Install the necessary drivers to activate the devices.



The screen display and driver options vary under different operating system versions.



7.5.3 Utilities menu

The Utilities menu displays the software applications and utilities that the motherboard supports. Click an item to install.



7.5.4 Make disk menu

The Make disk menu contains items to create the Intel Rapid Storage Technology and LSI MegaRAID driver disks.



7.5.5 Contact information

Click the Contact tab to display the ASUS contact information. You can also find this information on the inside front cover of this user guide.



ASUS contact information

ASUSTeK COMPUTER INC.

Address 15 Li-Te Road, Peitou, Taipei, Taiwan 11259
Telephone +886-2-2894-3447
Fax +886-2-2890-7798
E-mail info@asus.com.tw
Web site <http://www.asus.com>

Technical Support

Telephone +86-21-38429911
Fax +86-21-58668722 ext: 9101
Online Support <http://support.asus.com/techserv/techserv.aspx>

ASUSTeK COMPUTER INC. (Taiwan)

Address 15 Li-Te Road, Peitou, Taipei, Taiwan 11259
Telephone +886-2-2894-3447
Fax +886-2-2890-7798
E-mail info@asus.com.tw
Web site <http://tw.asus.com>

Technical Support

Telephone +886-2-2894-3447 (0800-093-456)
Online Support <http://support.asus.com/techserv/techserv.aspx>

ASUSTeK COMPUTER INC. (China)

Address No.508, Chundong Road, Xinzhuang Industrial Zone,
Minhang District, Shanghai, China.
Telephone +86-21-5442-1616
Fax +86-21-5442-0099
Web site <http://cn.asus.com>

Technical Support

Telephone +86-21-3407-4610 (800-820-6655)
Online Support <http://support.asus.com/techserv/techserv.aspx>

ASUS contact information

ASUS COMPUTER INTERNATIONAL (America)

Address 800 Corporate Way, Fremont, CA 94539, USA
Fax +1-510-608-4555
Web site <http://usa.asus.com>

Technical Support

Support fax +1-812-284-0883
General support +1-812-282-2787
Online support <http://support.asus.com/techserv/techserv.aspx>

ASUS COMPUTER GmbH (Germany and Austria)

Address Harkort Str. 21-23, 40880 Ratingen, Germany
Fax +49-2102-959911
Web site <http://www.asus.de>
Online contact <http://www.asus.de/sales>

Technical Support

Telephone +49-1805-010923
Support Fax +49-2102-959911
Online support <http://support.asus.com/techserv/techserv.aspx>