

FUJITSU LIFEBOOK A555



Congratulations on your purchase of an innovative product from Fujitsu.

The latest information about our products, tips, updates etc. can be found on the Internet at: ["http://www.fujitsu.com/fts/"](http://www.fujitsu.com/fts/)

You can find driver updates at: ["http://support.ts.fujitsu.com/download"](http://support.ts.fujitsu.com/download)

Should you have any technical questions, please contact:

- our Hotline/Service Desk (see the Service Desk list or visit: ["http://support.ts.fujitsu.com/contact/servicedesk"](http://support.ts.fujitsu.com/contact/servicedesk))
- Your sales partner
- Your sales office

We hope you enjoy working with your new Fujitsu system!



Published by / Contact address in the EU

Fujitsu Technology Solutions GmbH

Mies-van-der-Rohe-Straße 8

80807 Munich, Germany

["http://www.fujitsu.com/fts/"](http://www.fujitsu.com/fts/)

Copyright

© Fujitsu Technology Solutions GmbH 2014. All rights reserved.

Publication Date

12/2014

Order No.: A26391-K404-Z320-1-7619, edition 1

FUJITSU LIFEBOOK A555

Operating Manual

Innovative technology	7
Ports and controls	9
Important notes	12
First-time setup of your device	16
Working with the notebook	19
Security functions	39
Connecting external devices	43
Removing and installing components during servicing	47
Settings in BIOS Setup Utility	55
Troubleshooting and tips	58
Technical data	65
Manufacturer's notes	67
Index	69

Remarks

Information on the product description meets the design specifications of Fujitsu and is provided for comparison purposes. Several factors may cause the actual results to differ. Technical data is subject to change without prior notification. Fujitsu rejects any responsibility with regard to technical or editorial mistakes or omissions.

Trademarks

Fujitsu, the Fujitsu logo and LIFEBOOK are registered trademarks of Fujitsu Limited or its subsidiaries in the United States and other countries.

Microsoft and Windows are trademarks or registered trademarks of the Microsoft Corporation in the United States and/or other countries.

Adobe Reader is a trademark of Adobe Systems Incorporated.

All other trademarks specified here are the property of their respective owners.

Copyright

No part of this publication may be copied, reproduced or translated without the prior written consent of Fujitsu.

No part of this publication may be saved or transferred by any electronic means without the written approval of Fujitsu.

Contents

Innovative technology	7
Further information	7
Notational conventions	8
Ports and controls	9
Important notes	12
Safety notes	12
Additional safety notes for devices with radio components	12
Energy saving	13
Energy saving under Windows	13
Travelling with your notebook	14
Before you travel	14
Notebook: transporting	14
Cleaning the notebook	15
First-time setup of your device	16
Unpacking and checking the device	16
Selecting a location	17
Mains adapter connecting	17
Switching on the device for the first time	18
Working with the notebook	19
Status indicators	19
Switching on the notebook	20
Notebook: switching off	21
Keyboard	22
Separate number block	24
Key combinations	24
Country and keyboard settings	26
Touchpad and touchpad buttons	26
Moving the pointer	26
Selecting an item	27
Executing commands	27
Dragging items	27
Switching the Touchpad on and off	27
LCD screen	28
Webcam	29
Rechargeable battery	30
Charging, caring for and maintaining the battery	30
Removing and installing the battery	30
Optical drive (optional)	32
Handling data carriers	32
CD/DVD indicator	33
Inserting or removing a data carrier	33
Manual removal (emergency removal)	34
Using the power-management features	35
Memory cards	36
Supported formats	36
Inserting the memory card	36
Removing the memory card	36
Loudspeakers and microphones	37

Wireless LAN / Bluetooth	37
Switching the wireless components on and off	37
Setting up WLAN access	37
Ethernet and LAN	38
Security functions	39
Using the Security Lock	39
Configuring password protection in BIOS Setup Utility	40
Protecting BIOS Setup Utility (supervisor and user password)	40
Password protection for booting of the operating system	41
Password protection for the hard disk	42
Connecting external devices	43
Connecting an external monitor	43
HDMI port	44
Connecting USB devices	44
USB port with charging function (Anytime USB charge)	45
How to remove USB devices correctly	45
Headset port	46
Removing and installing components during servicing	47
Notes on installing and removing boards and components	47
Preparing to remove components	48
Installing and removing memory expansion	48
Removing the cover	49
Removing memory modules	49
Installing a memory module	50
Securing the cover	50
Removing and installing the hard disk	51
Removing a cover	51
Removing a hard disk	52
Installing a hard disk	53
Attaching the cover	54
Finishing component removal	54
Settings in BIOS Setup Utility	55
Starting the BIOS Setup Utility	55
Operating BIOS Setup Utility	56
Exiting BIOS Setup Utility	57
Exit Saving Changes - save changes and exit BIOS Setup Utility	57
Exit Discarding Changes – Discard changes and exit BIOS Setup Utility	57
Load Setup Defaults – Copy Standard Entries	57
Discard Changes – Discard changes without exiting the BIOS Setup Utility	57
Save Changes - save changes without exiting the BIOS Setup Utility	57
Save Changes and Power Off	57
Troubleshooting and tips	58
Help if problems occur	58
Restoring the hard disk contents under Windows	59
The notebook's date or time is incorrect	59
The notebook's LCD screen remains blank	59
The LCD screen is difficult to read	60
The external monitor remains blank	60
The external monitor is blank or the image is unstable	60

The notebook cannot be started	61
The notebook stops working	61
The printer does not print	62
The radio connection to a network does not work	62
Acoustic warnings	62
Error messages on the screen	63
Technical data	65
LIFEBOOK	65
Rechargeable battery	65
Mains adapter (90W)	65
Mains adapter, 65 W	66
Manufacturer's notes	67
Disposal and recycling	67
Declarations of Conformity	67
CE marking	67
Other certification markings	68
Index	69

Innovative technology

... and ergonomic design make your device a reliable and convenient companion.

The device boots very quickly, is ready for immediate use and offers a particularly long operating time because of its high capacity battery.

With the user-friendly "BIOS Setup Utility" you can control your notebook's hardware and better protect your system against unauthorised access by using the powerful password properties.



Information on the connections and user components of your notebook can be found in ["Ports and controls", Page 9.](#)

Further information







The Windows drivers for your device can be found on our Internet site. The factory installation of your device does not support any other operating system. Fujitsu Technology Solutions accepts no liability whatsoever if any other operating system is used.

Software oriented components of these instructions refer to Microsoft products, if they come within the scope of the delivery.

If you install other software products, pay attention to the operating instructions of the manufacturer.

Notational conventions

	<p>Pay particular attention to text marked with this symbol. Failure to observe these warnings could pose a risk to health, damage the device or lead to loss of data. The warranty will be invalidated if the device becomes defective through failure to observe these warnings.</p>
	<p>Indicates important information for the proper use of the device.</p>
	<p>Indicates an activity that must be performed</p>
	<p>Indicates a result</p>
<p>This font</p>	<p>indicates data entered using the keyboard in a program dialogue or at the command line, e.g. your password (Name123) or a command used to start a program (start.exe)</p>
<p>This font</p>	<p>indicates information that is displayed on the screen by a program, e.g.: Installation is complete.</p>
<p><i>This font</i></p>	<p>Indicates</p> <ul style="list-style-type: none"> • terms and texts used in a software interface, e.g.: Click on <i>Save</i> • names of programs or files, e.g. <i>Windows</i> or <i>setup.exe</i>.
<p>"This font"</p>	<p>Indicates</p> <ul style="list-style-type: none"> • cross-references to another section, e.g. "Safety information" • cross-references to an external source, e.g. a web address: For more information, go to "http://www.fujitsu.com/fts/" • Names of CDs, DVDs and titles or designations for other materials, e.g.: "CD/DVD Drivers & Utilities" or "Safety/Regulations" manual
<p>Key</p>	<p>indicates a key on the keyboard, e.g: F10</p>
<p>This font</p>	<p>indicates terms and texts that are emphasised or highlighted, e.g.: Do not switch off the device</p>

Ports and controls

This chapter presents the individual hardware components of your device. It gives an overview of the indicators and connections of the device. Please familiarise yourself with these components before you start to work with the device.

Front

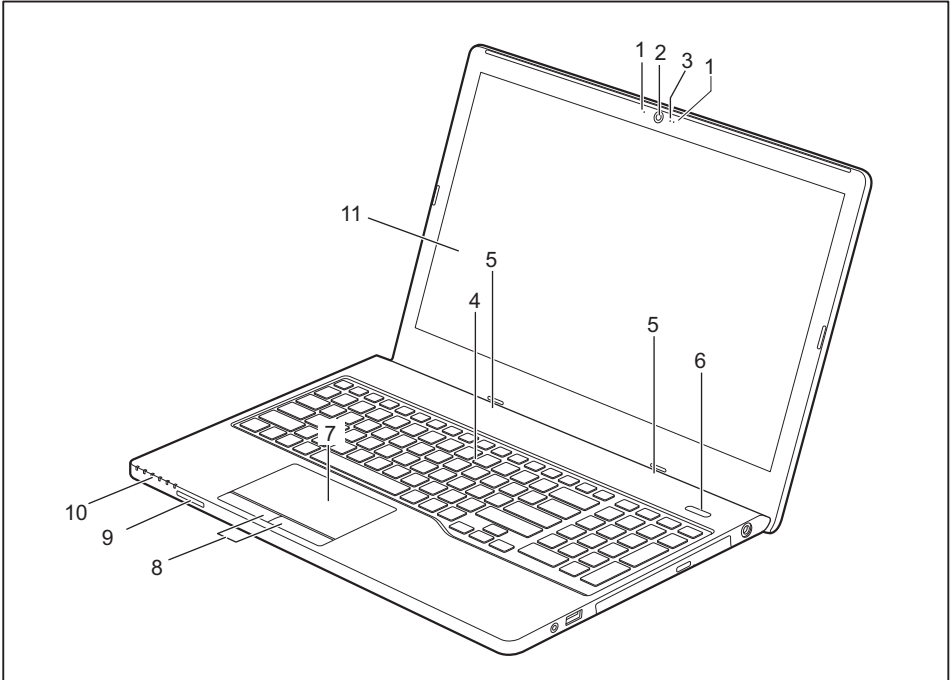

- 1 = Microphone
- 2 = Webcam
- 3 = WebCam LED
- 4 = Keyboard
- 5 = Loudspeakers
- 6 = ON/OFF switch

- 7 = Touchpad
- 8 = Touchpad buttons
- 9 = Memory card slot
- 10 = Status indicators
- 11 = LCD screen

Left panel

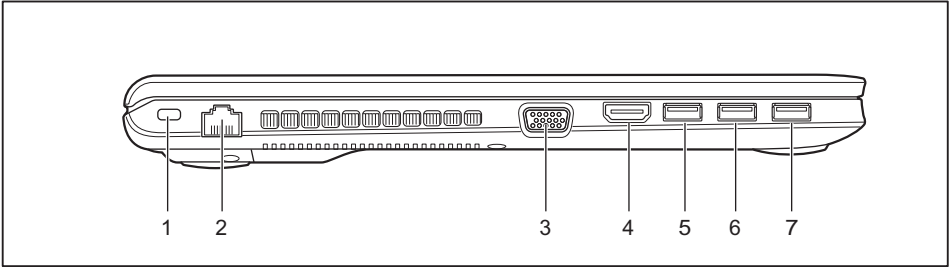

1 = Security Lock device

2 = LAN port

3 = VGA monitor port

4 = HDMI port

5 = USB port 3.0

6 = USB port 3.0

7 = USB port 3.0 with charging function
(Anytime USB charge)

Right-hand side

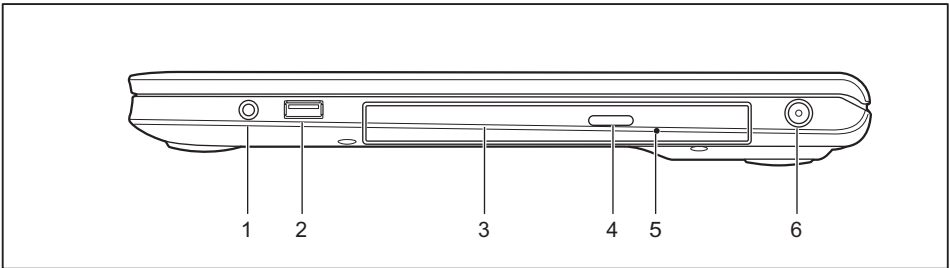

1 = Headset port

2 = USB port 2.0

3 = Optical drive (optional)

4 = Eject button, optical drive

5 = Opening for manual emergency removal

6 = DC input connector (DC IN)

Underside

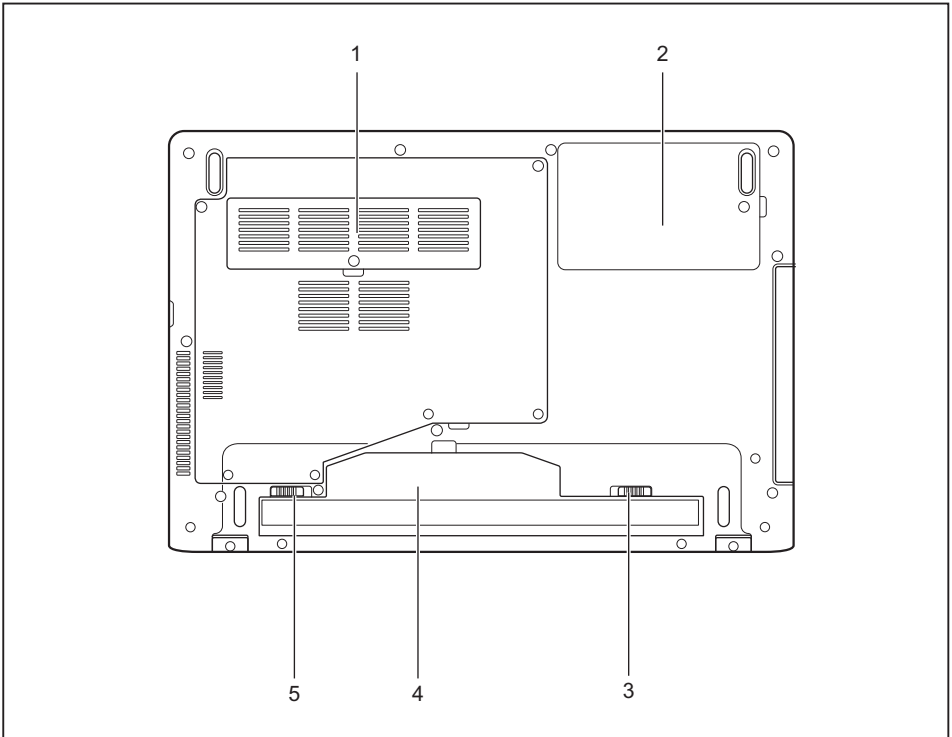

1 = Memory service compartment
2 = Hard disk service compartment
3 = Battery release

4 = Battery compartment
5 = Battery release

Important notes



This chapter contains essential safety information which must be followed when working with your notebook. Other notes also provide useful information which will help you with your notebook.

Safety notes



Please follow the safety notes provided in the "Safety/Regulations" manual as well as the safety notes given below.

Please pay special attention to the sections in the manual marked with the symbol on the left.

When connecting and disconnecting cables, observe the relevant notes in this operating manual.

Read the information on the ambient conditions in the ["Technical data", Page 65](#) and ["First-time setup of your device", Page 16](#) before preparing your notebook for use and switching it on for the first time.

When cleaning the device, please observe the relevant notes in the section ["Cleaning the notebook", Page 15](#).

Pay attention to the additional safety notes for devices with radio components provided in the "Safety/Regulations" manual.

Please refer to the notes in the chapter ["Removing and installing components during servicing", Page 47](#).

This notebook complies with the relevant safety regulations for data processing equipment. If you have questions about using your notebook in a particular area, please contact your sales outlet or our Hotline/Service Desk.

Additional safety notes for devices with radio components

If a radio component (Wireless LAN, Bluetooth, UMTS, LTE) is incorporated into your notebook, you must be sure to observe the following safety notes when using your notebook:

- Switch off the radio components when you are in an aircraft or driving in a car.
- Switch off the radio components when you are in a hospital, an operating room or near a medical electronics system. The transmitted radio waves can impair the operation of medical devices.
- Switch off the radio components when you let the device get near flammable gases or into hazardous environments (e.g. petrol station, paintshops), as the transmitted radio waves can cause an explosion or a fire.



For information on how to switch radio components on and off, see chapter ["Switching the wireless components on and off", Page 37](#).

Energy saving

Switch the notebook off when it is not in use. Switch off external, connected devices if you are not using them. If you use the energy saving functions, the notebook uses less energy. You will then be able to work for longer before having to recharge the battery.



Energy efficiency is increased and the environmental impact is reduced. You save money while protecting the environment.

Energy saving under Windows

- ▶ Make use of the power management features (see ["Using the power-management features", Page 35](#)).

Travelling with your notebook

Please observe the points listed below when travelling with your notebook.

Before you travel

- ▶ Back up important data stored on your hard disk.
- ▶ Switch off the radio component for data security reasons. With data traffic via a wireless connection, it is also possible for unauthorised third parties to receive data.



Information on activating data encryption is provided in the documentation for your radio component.

- ▶ If you wish to use your notebook during a flight, first check with the flight attendants if it is OK to do so.

When travelling in other countries

- ▶ If you are travelling abroad, check that the mains adapter can be operated with the local mains voltage. If this is not the case, obtain the appropriate mains adapter for your notebook. Do not use any other voltage converter!
- ▶ Check whether the local mains voltage and the power cable are compatible. If this is not the case, buy a power cable that matches the local conditions.
- ▶ Enquire with the corresponding government office of the country you will be travelling in as to whether you may operate the radio component integrated in your notebook there (see also ["CE marking", Page 67](#)).

Notebook: transporting



Protect the notebook from severe shocks and extreme temperatures (e.g. direct sunlight in a car).

- ▶ If your device has an optical drive, remove all data media (e.g. CD, DVD) from the drives.
- ▶ Switch the notebook off.
- ▶ Unplug the mains adapter and all external devices from the power socket.
- ▶ Disconnect the mains adapter cable and the data cables for all external devices.
- ▶ Close the LCD screen.
- ▶ To protect against damaging jolts and bumps, use a notebook carrying case to transport your notebook.

Cleaning the notebook



Do not clean any interior parts yourself; leave this job to a service technician.

Only use cleaning products designed for computers. Normal household cleaners and polishes can damage the markings on the keyboard and the device, the paintwork or the notebook itself.

Ensure that no liquid enters the notebook.

The LCD screen very sensitive to scratches. Only clean the display surface with a very soft, slightly damp cloth.

- ▶ Switch the notebook off.
- ▶ In order to prevent accidentally switching the device on, remove the power cable from the mains adaptor and remove the battery (see ["Removing and installing the battery", Page 30](#)).
- ↳ The surface can be cleaned with a dry cloth. If particularly dirty, use a cloth which has been moistened in mild domestic detergent and then carefully wrung out.
To clean the keyboard and the touchpad, if available, you can use disinfectant wipes.
Ensure that no liquid enters the device.

First-time setup of your device



Please read the chapter ["Important notes", Page 12.](#)

If your device is equipped with a Windows operating system, the necessary hardware drivers and supplied software are already pre-installed.

Before you switch on the device for the first time, connect it to the mains voltage using the mains adapter, see ["Mains adapter connecting", Page 17.](#) The mains adapter must be connected during the entire installation process.

A system test is performed when your device is first switched on. Various messages can appear. The display may remain dark for a short time or may flicker.

Please follow the instructions on the screen.

NEVER switch off your device during the first-time setup process.

On delivery, the battery can be found in the battery compartment or in the accessories kit. The battery must be charged if you want to operate your device using the battery.

When used on the move, the built-in battery provides the device with the necessary power. You can increase the operating time by using the available energy-saving functions.

For instructions on how to connect external devices (e.g. mouse, printer) to your device, please refer to the operating manual for your device.

Unpacking and checking the device



Should you discover any damage that occurred during transportation, notify your local sales outlet immediately!

- ▶ Unpack all the individual parts.
- ▶ Check your device for any visible damage which may have occurred during transportation.



You may need the packaging in the future, if you need to transport your device.

Selecting a location



Select a suitable location for the device before setting it up. Follow the instructions below when doing so:

- Never place the device or the mains adapter on a heat-sensitive surface. The surface could be damaged as a result.
- Never place the device on a soft surface (e.g. carpeting, upholstered furniture, bed). This can block the air vents and cause overheating and damage.
- The underside of the device heats up during normal operation. Prolonged contact with the skin may become unpleasant or even result in burns.
- Place the device on a stable, flat, non-slippery surface. Please note that the rubber feet of the device may mark certain types of delicate surfaces.
- Keep other objects at least 100 mm / 3.97" away from the device and its mains adapter to ensure adequate ventilation.
- Never cover the ventilation slots of the device.
- Do not expose the device to extreme environmental conditions. Protect the device from dust, humidity, and heat.

Mains adapter connecting



Observe the safety notes in the enclosed "Safety/Regulations" manual.

The supplied power cable conforms to the requirements of the country in which you purchased your device. Make sure that the power cable is approved for use in the country in which you intend to use it.

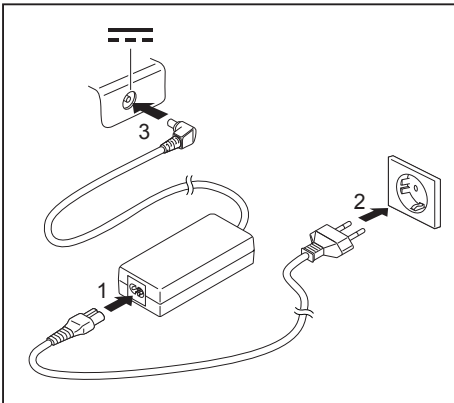

- ▶ Connect the power cable (1) to the mains adapter.
- ▶ Plug the mains cable (2) into a mains outlet.
- ▶ Connect the mains adapter cable (3) to the DC jack (DC IN) of the device.

Switching on the device for the first time



When you switch on the device for the first time, the supplied software is installed and configured. Because this procedure must not be interrupted, you should set aside enough time for it to be fully completed and connect the device to the mains using the mains adapter.

During the installation process, DO NOT restart the device unless you are requested to do so!

To make it easier to use your device for the first time, the operating system is pre-installed on the hard disk.

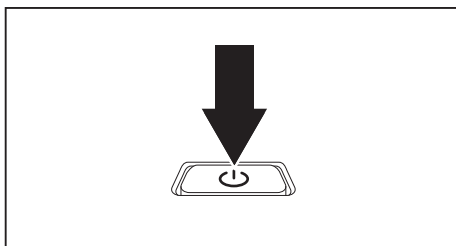

► Switch on your device.

► During installation, follow the instructions on screen.



If a Windows operating system is installed on your device, you will find more information on the system and drivers, help programmes, updates, manuals etc. on the device or on the Internet at ["http://www.fujitsu.com/fts/support/"](http://www.fujitsu.com/fts/support/).

You can find information and help on the Windows operating system functions on the Internet at ["http://windows.microsoft.com"](http://windows.microsoft.com).

Working with the notebook

This chapter describes the basics for operating your notebook. Please read the chapter entitled "[Connecting external devices](#)", [Page 43](#) for instructions on how to connect devices such as a mouse and a printer to the notebook.







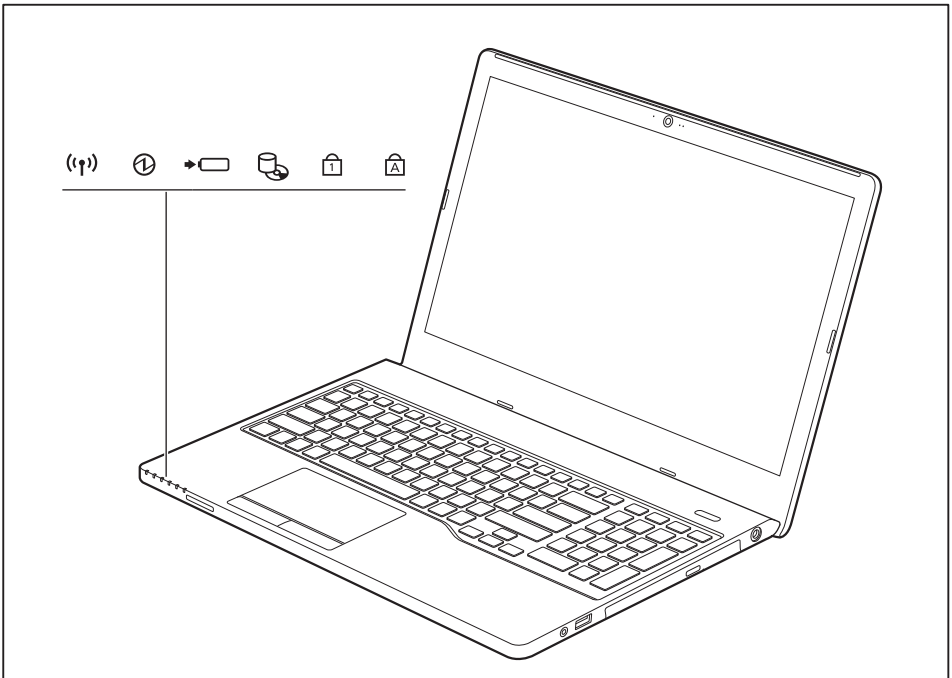

Please refer to the notes in "[Important notes](#)", [Page 12](#).

Status indicators

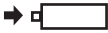
The status indicators provide information about the status of the power supply, the drives and the keyboard functions.



Status indicators	Description
	<p>Wireless components indicator</p> <ul style="list-style-type: none"> The indicator is lit: The wireless components are switched on. The indicator is not lit: The wireless components are switched off.
	<p>Power-on indicator/Standby</p> <ul style="list-style-type: none"> The indicator is lit: The notebook is switched on. The indicator flashes: The notebook is in standby mode. The indicator is not lit: The notebook is switched off.
	<p>Battery charging indicator/power connector</p> <p>The state of charge of the battery is shown by the battery indicator.</p> <p>Without the mains adapter connected:</p> <ul style="list-style-type: none"> Indicator is off: The system is in battery operation. <p>With mains adapter connected:</p> <ul style="list-style-type: none"> The indicator is illuminated (orange): The battery is charging. Indicator is white: The battery is fully charged. Indicator flashes orange and white alternately: a fault has occurred. The battery cannot be recharged. Indicator is off: There is no battery installed.
	<p>Drive indicator</p> <p>Indicator is illuminated: One of the drives (e.g. hard disk, optical drive) is being accessed.</p>
	<p>Num Lock indicator</p> <p>The indicator is lit: The <input type="text" value="Num"/> key has been pressed. The virtual numerical keypad is activated. You can output the characters indicated on the upper right of the keys.</p>
	<p>Caps Lock indicator</p> <p>The indicator is lit: The Caps Lock key has been pressed. All the characters you type will appear in upper case. In the case of overlay keys, the character printed on the upper left of the key will appear when that key is pressed.</p>

Switching on the notebook

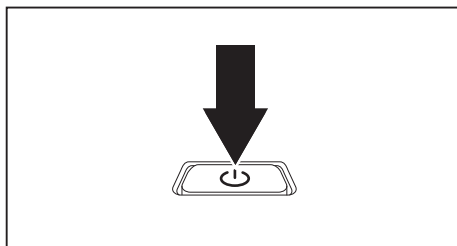

- ▶ Open the LCD screen.
- ▶ Press the ON/OFF switch for about one second to switch the notebook on.

↳ The power-on indicator is lit.

Notebook: switching off



Back up your data and close all applications before you switch off your device. Otherwise data might be lost.

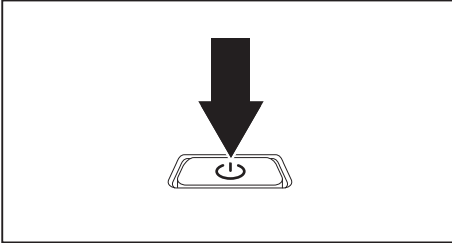

- ▶ Shut down the operating system correctly.
- ▶ If the notebook is not switched off automatically, press the ON/OFF switch for approx. five seconds.
- ▶ Close the LCD screen.

Keyboard



The keyboard of your notebook is subject to continuous wear through normal use. The key markings are especially prone to wear. The key markings are liable to wear away over the life of the notebook.

The keyboard has been designed to provide all the functions of an enhanced keyboard. Some enhanced keyboard functions are mapped with key combinations.





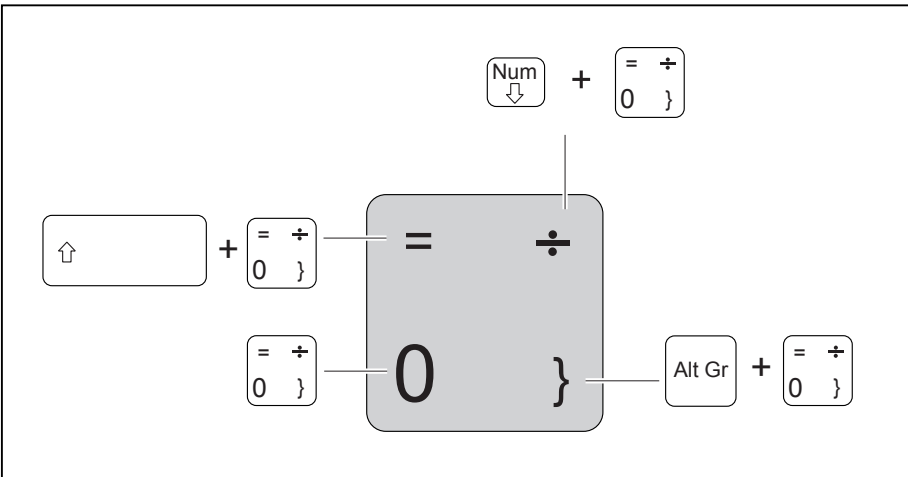

The following description of keys refers to Windows. Additional functions supported by the keys are described in the relevant manuals supplied with your application programs.

The figure below shows how to access the different characters on keys with overlaid functions. The example applies when the Caps Lock key has not been activated.

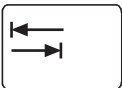

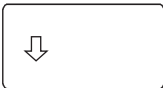
The illustrations shown below may differ from your actual device.

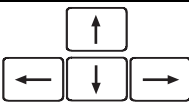

Key	Description
	Backspace key The Backspace key deletes the character to the left of the cursor.
	Tab key The Tab key moves the cursor to the next tab stop.
	Enter key (return) The Enter key terminates a command line. The command you have entered is executed when you press this key.
	Caps Lock key The Caps Lock key activates the Caps Lock mode, and the corresponding icon is displayed in the Windows information area. In Caps Lock mode, all of the characters you type appear in upper case. In the case of overlay keys, the character printed on the upper left of the key will appear when that key is pressed. To cancel the Caps Lock function, simply press the Caps Lock key again.
	Shift key The Shift key causes uppercase characters to appear. In the case of overlay keys, the character printed on the upper left of the key appears when that key is pressed.
	Fn button The [Fn] key enables the special functions indicated on overlay keys (see "Key combinations", Page 24).
	Cursor keys The cursor keys move the cursor in the direction of the arrow, i.e. up, down, left, or right.
	Windows key The Windows key switches between the start screen and the last used application.
	Menu key The Menu key opens the menu for the active application.

Separate number block

The keyboard of your notebook has a separate number block on the far right.

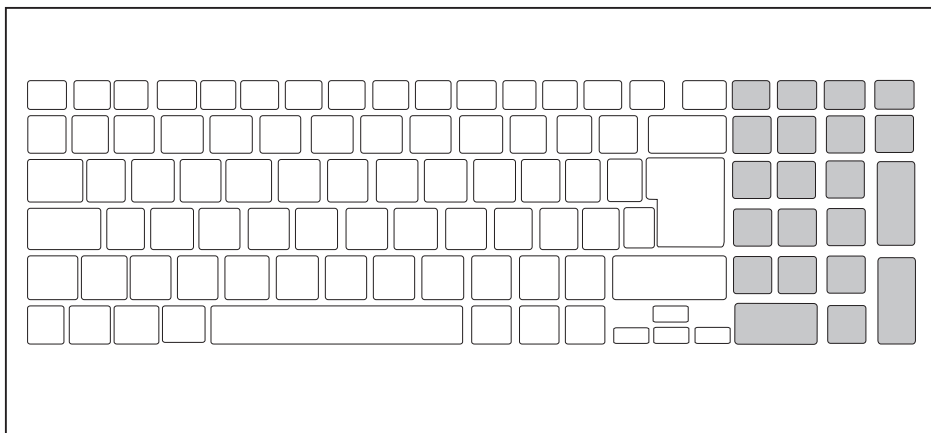







Key combinations



















The following description of key combinations applies to Windows operating systems. Some of the following key combinations may not function in other operating systems or with certain device drivers.

Other key combinations are described in the relevant manuals supplied with your application programs.

Key combinations are entered as follows:

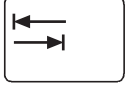
- ▶ Press the first key in the combination and keep it pressed.
- ▶ While holding the first key down, press the other key or keys in the combination.

Combination	Description
 + 	Switching the loudspeakers on and off This key combination switches your notebook's loudspeakers off and on.
 + 	Switching the touchpad and touchpad buttons on/off This key combination switches the touchpad and the touchpad buttons on or off.
 + 	Switching the wireless components on / off This key combination switches the wireless components off or on.

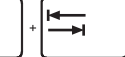
Combination	Description
 + 	Decrease screen brightness This key combination decreases the brightness of the screen.
 + 	Increase screen brightness This key combination increases the brightness of the screen.
 + 	Decrease volume This key combination reduces the volume of the internal loudspeakers.
 + 	Increase volume This key combination increases the volume of the internal loudspeakers.
 + 	Toggle output screen Use this key combination to select which screen(s) is/are used for display if an external monitor is connected. Screen output is possible: <ul style="list-style-type: none"> • only on the notebook's LCD screen • on the LCD screen of the notebook and the external monitor at the same time • only on the external monitor This setting is useful if you would like a high resolution and a high refresh rate on an external monitor.
 + 	Power management functions Use this key combination to activate the power management functions (see chapter " Using the power-management features ", Page 35).
 + 	Switch webcam and microphone on/off This key combination switches the webcam and microphone on or off, provided the webcam has been enabled in the BIOS Setup utility.
 + 	Switch between open applications Use this key combination to switch between several open applications.
 +  + 	Windows security/Task-Manager This key combination opens the Windows security/Task-Manager window.
 + 	Back tab This key combination moves the cursor back to the previous tab stop.



Key combinations using the Windows keys are detailed in the manual for your operating system.

Country and keyboard settings

- ▶ Change the country and keyboard settings as described in the documentation for your operating system.

Touchpad and touchpad buttons



Keep the touchpad clean. Protect it from dirt, liquids and grease.

Do not use the touchpad if your fingers are dirty.

Do not rest heavy objects (e.g. books) on the touchpad or the touchpad buttons.

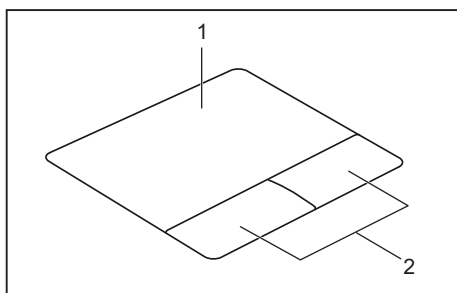

1 = Touchpad

2 = Touchpad buttons

The touchpad enables you to move the mouse pointer on the screen.

The touchpad buttons allow you to select and execute commands. They correspond to the buttons on a conventional mouse.



You can use a key combination to disable the touchpad, to avoid accidentally moving the pointer on the screen (see also ["Key combinations", Page 24](#)).

Moving the pointer

- ▶ Move your finger on the touchpad.
- ↳ The pointer will move.

Selecting an item

- ▶ Move the pointer to the item you wish to select.
- ▶ Tap the touchpad once or press the left button once.
- ↳ The item is selected.

Executing commands

- ▶ Move the pointer to the field you wish to select.
- ▶ Tap the touchpad twice or press the left button twice.
- ↳ The command is executed.

Dragging items

- ▶ Select the desired item.
- ▶ Press and hold the left button and, with your finger on the touchpad, drag the item to the desired position.
- ↳ The item will be moved.

Switching the Touchpad on and off



You can switch the Touchpad on and off using a key combination, see ["Key combinations", Page 24](#).

LCD screen

High-quality LCD screens (TFT) are installed in Fujitsu notebooks. For technical reasons, these screens are manufactured for a particular resolution. An optimum and sharp image can only be ensured with the resolution intended for the particular screen. A screen resolution which differs from the specification can result in an unclear image.

The resolution of your notebook's screen is set to the optimum at the factory.

Current production technology cannot guarantee an absolutely fault-free screen display. A few isolated constantly lit or unlit pixels may be present. The maximum permitted number of faulty pixels is stipulated in the international standard ISO 9241-307 (Class 4).

Example:

A screen with a resolution of 1280 x 800 has $1280 \times 800 = 1024000$ pixels. Each pixel consists of three subpixels (red, green and blue), so there are almost 3 million subpixels in total. According to ISO 9241-307 (class 4), a maximum of 2 light and 2 dark pixels and in addition 5 light or 10 dark subpixels or an equivalent mix (1 light subpixel counts as 2 dark subpixels) are allowed to be defective.

Pixel	A pixel consists of 3 subpixels, normally red, green and blue. A pixel is the smallest element that can be generated by complete functionality of the display.
Subpixel	A subpixel is a separately addressable internal structure within a pixel that enhances the pixel function.
Cluster	A cluster contains two or more defective pixels or subpixels in a 5 x 5 pixel block.

Background lighting

LCD screens are operated with background lighting. The luminosity of the background lighting can decrease during the period of use of the notebook. However, you can set the brightness of your screen individually.

Synchronising the display on the LCD screen and an external monitor

For more information, please refer to the chapter "[Key combinations](#)", [Page 24](#) under "Display output, switch between".

Webcam

Depending on the software used, you can use your Webcam to take pictures, record video clips or take part in web chats.

- The picture quality depends on the lighting conditions and the software being used.
- You can only operate the webcam with a particular application (e.g. an Internet telephony program or a video conferencing program which supports a webcam).
- When using the webcam the notebook support must not wobble.
- The webcam automatically adjusts itself to the current light level. For this reason the LCD screen may flicker while the light level is adjusted.



Further information on using the webcam and on the additional settings which are possible for your webcam can be found in the help function of the program which uses the webcam.

Rechargeable battery

When not plugged into a mains socket, the notebook runs on its built-in battery. You can increase the life of the battery by caring for the battery properly. The average battery life is around 500 charge/discharge cycles.

You can extend the battery life by taking advantage of the available energy saving functions.

Charging, caring for and maintaining the battery

The notebook battery can only be charged when the ambient temperature is between 5°C / 41°F and max. 35°C / 95°F.

You can charge the battery by connecting the notebook to the mains adapter (see ["Mains adapter connecting", Page 17](#)).

If the battery is running low you will hear a warning alarm. If you do not connect the mains adapter within five minutes of the warning alarm described above, your notebook will automatically switch off.

monitoring the battery charging level

Windows also has a "Battery status meter" in the taskbar for monitoring the battery capacity. When you place the mouse pointer on the battery symbol, the system displays the battery status.

Battery storage

Store battery packs in a dry environment at a temperature between 0°C / 32°F and 30°C / 86°F. The lower the temperature at which the batteries are stored, the lower the rate of self-discharge.



If you will be storing batteries for a longer period (longer than two months), the battery charge level should be approx. 30 %. To prevent exhaustive discharge which would permanently damage the battery, check the level of charge of the battery at regular intervals.

To be able to make use of the optimal charging capacity of the batteries, the battery should be completely discharged and then fully recharged.



If you do not use the batteries for long periods, remove them from the notebook. Never store the batteries in the device.

Removing and installing the battery



Only use batteries approved by Fujitsu for your notebook.

Never use force when fitting or removing a battery.

Make sure that no foreign bodies get into the battery connections.

Never store a battery for long periods in the discharged state. This can make it impossible to recharge.

Removing the battery

- ▶ Prepare for removal, see chapter ["Preparing to remove components", Page 48.](#)

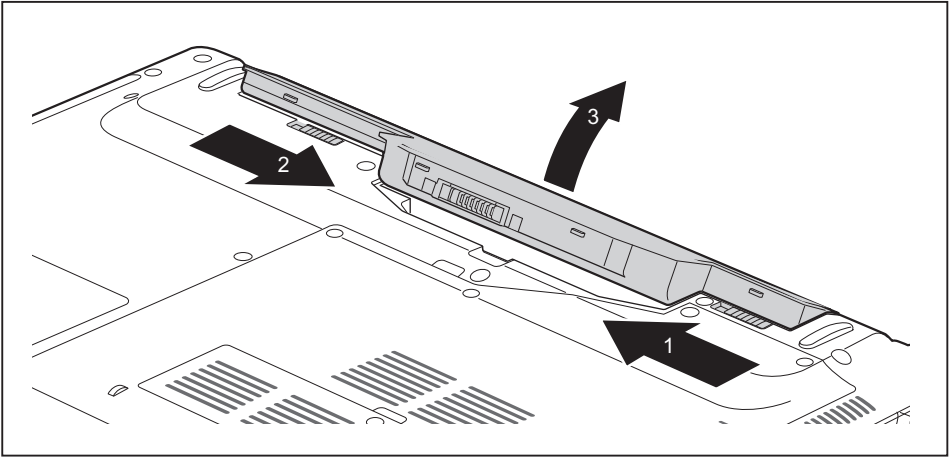

- ▶ Slide the release button in the direction of the arrow (1).
- ▶ Slide the release button in the direction of the arrow (2) and hold it in place.
- ▶ Remove the battery from the battery compartment (3).

Inserting battery

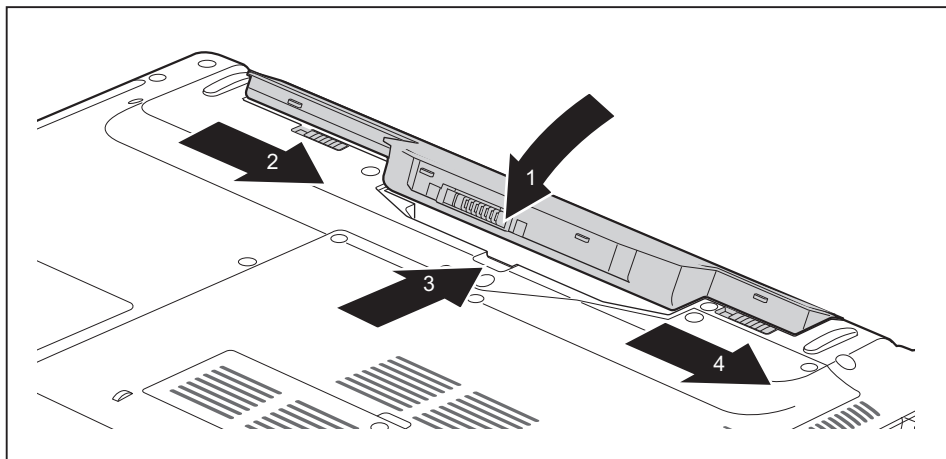

- ▶ Position the rechargeable battery at the edge and fold it in the direction of the arrow (1).
- ▶ Slide the release button in the direction of the arrow (2) and hold it in place.
- ▶ Slide the rechargeable battery in the direction of the arrow (3) until you feel it engage.
- ▶ Slide the release button in the direction of the arrow (4).
- ▶ Complete the removal, see chapter ["Finishing component removal", Page 54](#).

Optical drive (optional)



This product contains a light emitting diode, classification according to IEC 60825 1:2007: LASER CLASS 1, and must therefore not be opened.

Handling data carriers

Observe the following guidelines when handling data carriers:

- Avoid touching the surface of a data carrier. Only handle data carriers by their edges.
- Always store data carriers in their cases. This will protect the data carrier against being covered in dust, scratched or damaged in any other way.
- Protect your data carriers against dust, mechanical vibrations and direct sunlight.
- Avoid storing a data carrier in areas subject to high temperatures or humidity.

You can use data carriers with a diameter of 8 cm / 3.15" or 12 cm / 4.7" in the drive.

When using a data carrier of lesser quality, vibrations and reading errors may occur.

CD/DVD indicator

The CD/DVD indicator flashes when a data carrier is inserted. The indicator goes out when the drive is ready for reading. The indicator lights up when the drive is being accessed. You may only remove the data carrier when the indicator is unlit.



If the CD/DVD indicator does not go out after a data carrier has been inserted, but instead continues to flash, this means that the drive cannot access the data carrier.

Either the data carrier is damaged or dirty or you are using a data carrier that the drive cannot read.

Inserting or removing a data carrier

The notebook must be switched on.

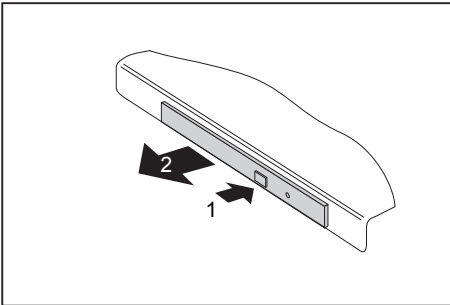

- ▶ Push the insert/eject button (1).
- ↳ The drive tray will open.
- ▶ Gently pull the drive tray (2) completely out.

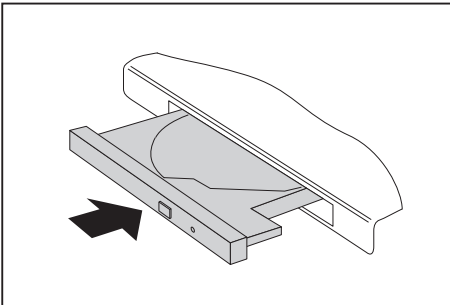

- ▶ Place the data carrier in the drive tray with the printed side facing upwards.

or

- ▶ Remove a data carrier that has been inserted.
- ▶ Push in the drive tray until you feel it lock into place.

Manual removal (emergency removal)

In the event of a power failure or damage to the drive, you can remove the data carrier manually.

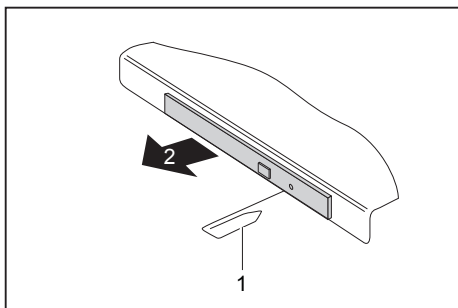

- ▶ Switch your notebook off.
- ▶ Push a pen or a piece of wire (such as a paperclip) firmly into the opening (1).
- ↳ The drive tray is ejected. You can now pull the drive tray (2) out of the drive.

Using the power-management features

The notebook uses less power when the available power-management features are used. You will then be able to work longer when using the battery before having to recharge it.



Power efficiency is increased and environmental pollution reduced. By choosing the best power options, you can make significant savings and at the same time help protect the environment.

When you close the LCD screen, depending on the setting in Windows, the notebook automatically enters a power saving mode.

We recommend the following settings:

Function	On external power	On battery power
Turn off monitor	After 10 minutes	After 5 minutes
Turn off hard disk(s)	After 15 minutes	After 10 minutes
Energy saving (S3)	After 20 minutes	After 15 minutes
Hibernate mode (S4)	After 1 hour	After 30 minutes

- ▶ Select the power management functions in your Control Panel.
- ▶ Select the Screen Saver in your Control Panel.

or

- ▶ Right-click on the desktop. Activate the screen saver by clicking on *Personalize – Change Screen Saver*.



If you need further information about an option, you can get help with most settings by pressing **F1** to open the Microsoft Help.

When the notebook is in power-saving mode, the following must be remembered:



During power saving mode, open files are held in the main memory or in a swap file on the hard disk.

Never turn off your notebook while it is in a power saving mode. If the built-in battery is nearly empty, close the open files and do not go into power saving mode.

If you do not intend to use your notebook for a long period of time:

- ▶ Exit power saving mode if necessary via the mouse or keyboard or by switching on the notebook.
- ▶ Close all opened programs and completely shut down the notebook.

Memory cards

Your notebook is equipped with an integrated memory card reader.



Observe the manufacturer's instructions when handling the memory cards.

Supported formats

Your notebook supports the following formats:

- SDHC
- SDXC

Inserting the memory card

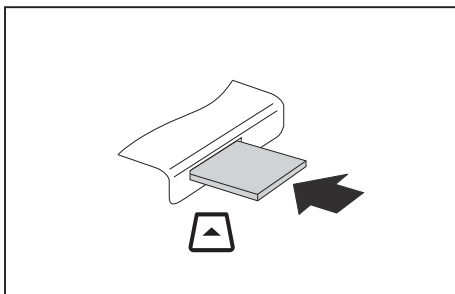

- ▶ Carefully slide the memory card into the slot. The label should be facing upward. Do not apply excessive force, as otherwise the delicate contact surfaces could be damaged.
- ↳ Depending on the particular type used, the memory card may protrude slightly from the slot.

Removing the memory card



To avoid any loss of data, always follow the correct procedure for removing the card (see the documentation for your operating system).

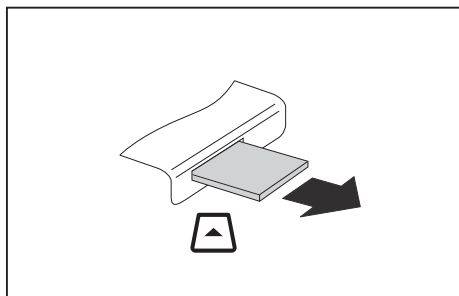

- ▶ Pull the memory card out of the slot.

Loudspeakers and microphones

You will find information about the exact position of speakers and microphones in chapter "[Ports and controls](#)", [Page 9](#).

Please refer to chapter "[Key combinations](#)", [Page 24](#) for information on setting the volume and also enabling/disabling the loudspeakers using key combinations.



If you attach an external microphone, the built-in microphone is disabled.

When you connect headphones or external speakers, the built-in speakers are disabled.

Information on connecting headphones and a microphone can be found in "[Connecting external devices](#)", [Page 43](#).

Wireless LAN / Bluetooth



The installation of radio components not approved by Fujitsu will invalidate the certifications issued for this device.

Switching the wireless components on and off

- ▶ Press the key combination **[Fn] + [F5]** to start the *WirelessSelector*.
- ↳ The wireless component indicator will illuminate when one or more wireless components are switched on.



The Bluetooth module and the wireless LAN transmission unit (antenna) will be switched off when you switch off the radio components.

Pay attention to the additional safety notes for devices with wireless components provided in the "Safety" manual.

Details on using a Wireless LAN can be found in the online help system included in the Wireless LAN software.

Setting up WLAN access

- Requirement: A WLAN must be available and you must have the corresponding access information.



Information on configuring the WLAN access can be found in the documentation for your operating system.

Ethernet and LAN

The internal network module of your notebook supports Ethernet LAN. You can use it to establish a connection to a local network (LAN = Local Area Network).

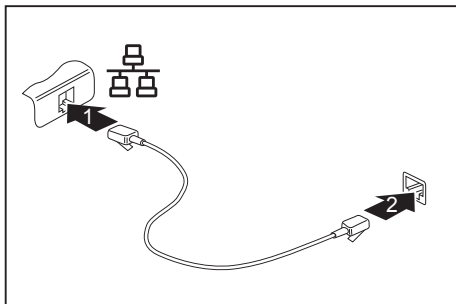

- ▶ Connect the network cable to the LAN port of the notebook (1).
- ▶ Connect the network cable to your network connection (2).



Your network administrator can help you to configure and use the LAN connections.

The network cable is not included in the delivery scope. This type of cable can be obtained from a specialist dealer.

Security functions

Your notebook has several security features that you can use to secure your system from unauthorised access.

This chapter explains how to use each function, and what the benefits are.



Please remember that in some cases, for example, forgetting your password, you may be locked out and unable to access your data. Therefore, please note the following information:

- Make regular backups to external data carriers such as external hard drives, CDs, DVDs or Blu-ray Discs.
- Some security functions need you to choose passwords. Make a note of the passwords and keep them in a safe place.

If you forget your passwords you will need to contact our Service Desk. Deletion or resetting of passwords is not covered by your warranty and a charge will be made for assistance.

Using the Security Lock

Your device comes with a Security Lock mechanism for the Kensington Lock Cable. You can use the Kensington Lock Cable, a sturdy steel cable, to help protect your notebook from theft. The Kensington Lock Cable is available as an accessory.



Fujitsu recommends the use of a combination lock.

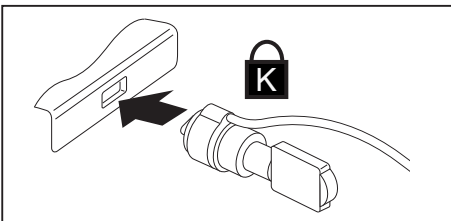

- ▶ Fit the Kensington Lock Cable to the mechanism on your notebook.

Configuring password protection in BIOS Setup Utility



Before using the various options for password protection in the *BIOS Setup utility* to increase data security, please observe the following:

Make a note of the passwords and keep them in a safe place. If you forget your supervisor password you will not be able to access your notebook. Deletion of the password is not covered by your warranty and a charge will be made for assistance.



Your password can be up to eight characters long and contain letters and numbers. No distinction is made between uppercase and lowercase.

Protecting BIOS Setup Utility (supervisor and user password)



If you have opened these operating instructions on the screen, we recommend that you print them out. You cannot call the instructions onto the screen while you are setting up the password.

The supervisor password and the user password both prevent unauthorised use of the *BIOS Setup Utility*. With the aid of the supervisor password you can access all of the functions of the *BIOS Setup Utility*, while the user password will only give you access to some of the functions. You can only set up a user password if a supervisor password has already been assigned.



Please refer to section ["Settings in BIOS Setup Utility", Page 55](#) for a description of how to call up and operate the *BIOS-Setup-Utility*.

Assigning the supervisor and user passwords

- ▶ Start the *BIOS Setup Utility* and go to the *Security* menu.
- ▶ Select the *Set Supervisor Password* field and press the Enter key.
- ↳ With *Enter new Password*: you are asked to enter a password.
- ▶ Enter the password and press the Enter key.
- ↳ *Confirm new Password* requires you to confirm the password.
- ▶ Enter the password again and press the Enter key.
- ↳ *Changes have been saved* is a confirmation that the new password has been saved.
- ▶ To set the user password, select *Set User Password* and proceed exactly as when configuring the supervisor password.
- ↳ If you do not want to change any other settings, you can exit *BIOS Setup Utility*.
- ▶ In the *Exit* menu, select the option *Save Changes & Exit*.
- ▶ Select *Yes* and press the Enter key.
- ↳ The notebook is then rebooted and the new password comes into effect. It will now be necessary to first enter your supervisor or user password in order to open the *BIOS Setup Utility*. Please note that the user password only provides access to a few of the BIOS settings.

Changing the supervisor or user password

You can only change the supervisor password when you have logged into the *BIOS Setup Utility* with the supervisor password.

- ▶ Call the *BIOS Setup Utility* and go to the *Security* menu.
- ▶ When changing the password, proceed exactly as for password assignment.

Removing passwords

To remove a password (without setting a new password) perform the following steps:

- ▶ Start the *BIOS Setup Utility* and go to the *Security* menu.
- ▶ Highlight the *Set Supervisor Password* or *Set User Password* field and press the Enter key.
 - ↳ You will be requested to enter the current password by the *Enter Current Password* prompt. You will be requested to enter a new password by the *Enter New Password* prompt.
- ▶ Press the Enter key twice.
- ▶ In the *Exit* menu, select the option *Save Changes & Exit*.
- ▶ Select *Yes* and press the Enter key.
- ↳ The notebook will now reboot with the password removed. Removing the supervisor password simultaneously deactivates the user password.

Password protection for booting of the operating system



With the supervisor password you have set in the *BIOS Setup Utility* (see section ["Assigning the supervisor and user passwords", Page 40](#)), you can also prevent starting of the operating system.

Activating system protection

- ▶ Start the *BIOS Setup Utility* and go to the *Security* menu.
- ▶ Select the *Password on Boot* option and press the Enter key.
- ▶ Select the desired option (*Disabled*, *First Boot* or *Every Boot*) and press the Enter key.
- ▶ Select the *Save Changes & Exit* option under *Exit*.
- ↳ The notebook reboots. You will be prompted to enter your password (the supervisor password).

Deactivating system protection

- ▶ Start the *BIOS Setup Utility* and go to the *Security* menu.
- ▶ Select the *Password on Boot* option and press the Enter key.
- ▶ Select the *Disabled* option and press the Enter key.
- ↳ If you do not want to change any other settings, you can exit *BIOS Setup Utility*.
- ▶ Select the *Save Changes & Exit* option under *Exit*.
- ↳ The notebook will reboot. The system is no longer password-protected.

Password protection for the hard disk



The hard disk password prevents unauthorised access to the hard disk drives and is checked internally each time the system is booted. The prerequisite for this is that you have assigned at least the supervisor password.

Activating hard disk protection

- ▶ Call up the *BIOS Setup* and select the *Security* menu.
- ↳ If you have not assigned BIOS passwords yet, define the supervisor and, if desired, the user password now (see "[Security functions](#)", Page 39).
- ▶ Mark the *Hard Disk Security* field and press the Enter key.
- ▶ In the *Drive0* area mark the *Set Master Password* field and press the Enter key.
- ↳ *Enter new Password* then appears and you are asked to enter a password.
- ▶ Enter the password and press the Enter key.
- ↳ *Confirm new Password* requires you to confirm the password.
- ▶ Enter the password again and press the Enter key.
- ↳ *Setup Notice: Changes have been saved* is displayed to confirm that the new password has been saved.
- ▶ To assign the password for the second hard disk (*Drive1*), go to the *Drive1* area and select the field *Set Master Password*, then proceed in exactly the same way as for setting up the password for the first hard disk (*Drive0*).
- ↳ The field *Password Entry on Boot* is set to *Enabled* by default. You can exit the *BIOS Setup* once you have finished changing the settings.
- ▶ From the *Exit* menu, choose the option *Exit Saving Changes*.
- ▶ Press the Enter key and select *Yes*.
- ↳ The notebook reboots and your hard disk is now protected with a password. The system will ask you to enter the password when the notebook is restarted again.

Deactivating hard disk protection

To cancel a password without setting a new one, proceed as follows:

- ▶ Call up the *BIOS Setup* and select the *Security* menu.
- ▶ Mark the *Hard Disk Security* field and press the Enter key.
- ▶ In the *Drive0* area mark the *Set Master Password* field and press the Enter key.
- ↳ You will be initially requested to enter the old password by the *Enter current Password* prompt. You will then be requested to enter a new password by the *Enter new Password* prompt.
- ▶ After entering the password, press the Enter key three times.
- ▶ From the *Exit* menu, choose the option *Exit Saving Changes*.
- ▶ Press the Enter key and select *Yes*.
- ↳ The notebook reboots, and password protection for the hard disk is cancelled.
- ▶ To cancel the password for the second hard disk (*Drive1*), go to the *Drive1* area and select the field *Set Master Password*, then proceed in exactly the same way as for cancelling the password for the first hard disk (*Drive0*).

Connecting external devices



Always refer to the safety information provided in ["Important notes", Page 12](#) before connecting or disconnecting any devices to or from your notebook.

Always read the documentation supplied with the device you wish to connect.

Never connect or disconnect cables during a thunderstorm.

Never pull at a cable when disconnecting it. Always grasp the plug.



With some devices such as USB devices, it is not necessary to switch off the notebook and the device before connecting/disconnecting. For more information about whether or not devices need to be switched off, please refer to the documentation supplied with the external device.

Some of the external devices require special drivers (see the operating system and external device documentation).

Connecting an external monitor

You can connect an external monitor to the analogue VGA monitor connection of the notebook. Screen output is limited to a maximum of two screens at any one time (see ["Key combinations", Page 24](#), section "Toggle output screen").

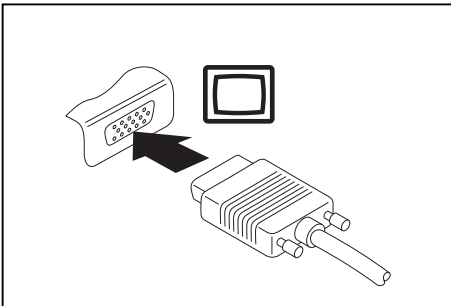

Analogue VGA monitor connection socket

- ▶ Switch off the notebook and the external monitor.
- ▶ Connect the data cable of the external monitor to the monitor port of the notebook.
- ▶ First switch on the external monitor and then the notebook.



You can also use a key combination to switch back and forth between the external monitor and the notebook's LCD screen, see chapter ["Key combinations", Page 24](#).

You can display the same picture on the external monitor and the notebook LCD screen simultaneously.

HDMI port

The HDMI port on your notebook can be used to connect an external amplifier, LCD TV or a plasma TV with an HDMI connection.

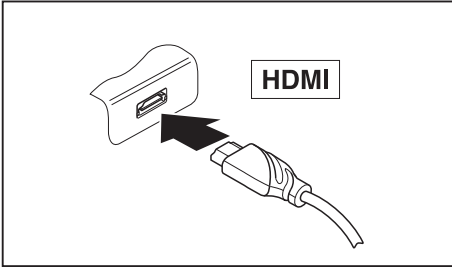

- ▶ Connect the data cable to the external device.
- ▶ Connect the data cable to the HDMI port of the notebook.

Connecting USB devices

On the USB ports, you can connect external devices that also have a USB port (e.g. a DVD drive, a printer, a scanner or a modem).



USB devices are hot-pluggable. This means you can connect and disconnect devices while your operating system is running.

USB 1.x has a maximum data transfer rate of 12 Mbit/s.

USB 2.0 has a data transfer rate of up to 480 Mbit/s.

USB 3.0 has a data transfer rate of up to 5 Gbit/s.

Additional information can be found in the documentation for the USB devices.

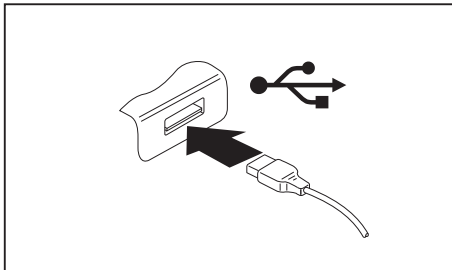

- ▶ Connect the data cable to the external device.
- ▶ Connect the data cable to a USB port of the notebook.



Device drivers

USB devices will be automatically recognised and installed by your operating system.

USB port with charging function (Anytime USB charge)



It is recommended that the notebook be operated with the power supply connected whenever the USB port with charging function is in use, as this function will drain the battery more quickly if an external USB device is being charged.

The power supply unit must already be connected when the notebook is switched off, as otherwise the USB charging function will be disabled and the connected USB devices will not be charged.



Some USB devices (e.g. mobile telephones) require a driver in order to utilise the USB charging function. In this case the USB charging function will not work when the notebook is switched off, as no drivers are active when the notebook is switched off.

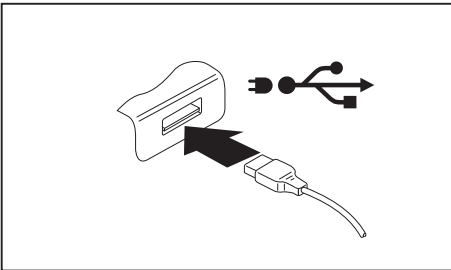

You can use this USB port to charge or supply power to a USB device (e.g. to charge a PDA or a mobile phone or to connect a USB lamp), even if the notebook is switched off.

How to remove USB devices correctly



Always correctly remove the device according to the rules described below, to ensure that none of your data is lost.

- ▶ Left click on the icon to safely remove hardware, located in the taskbar.
- ▶ Select the device which you want to shut down and remove.
- ▶ Press the Enter key.
- ↳ Wait for the dialogue box which tells you that it is now safe to remove the device.

Headset port

You can connect headsets, headphones or external loudspeakers to your notebook via the headset port.

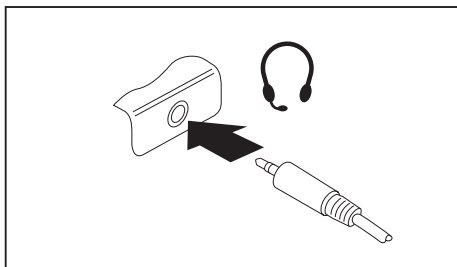

- ▶ Connect the audio cable to the external device.
- ▶ Connect the audio cable to the headset port of the notebook.
- ↳ The internal loudspeakers are disabled.



If you purchase a cable from a retailer, please note the following information:

The headset port on your notebook is a "3.5 mm jack socket".

If you want to connect headsets, headphones or a speaker you will need a "3.5 mm jack plug".

Removing and installing components during servicing



Only qualified technicians should repair your notebook. Unauthorised opening or incorrect repair may greatly endanger the user (electric shock, fire risk) and will invalidate your warranty.

After consulting the Hotline/Service Desk, you may remove and install the components described in this chapter yourself.



If you remove and install components without consulting the Hotline/Service Desk, then the warranty of your notebook will be voided.

Notes on installing and removing boards and components

- Switch the notebook off and pull the power plug out of the mains socket.
- Always remove the battery.
- Take care when you use the locking mechanisms on the battery and any other component.
- Never use sharp objects such as screwdrivers, scissors or knives as leverage to remove covers.



Boards with electrostatic sensitive devices (ESD) are marked with the label shown.

When handling boards fitted with ESDs, you must always observe the following points:

- You must always discharge static build up (e.g. by touching a grounded object) before working.
- The equipment and tools you use must be free of static charges.
- Remove the power plug from the mains supply before inserting or removing boards containing ESDs.
- Always hold boards with ESDs by their edges.
- Never touch pins or conductors on boards fitted with ESDs.

Preparing to remove components

If you are going to remove or change system components, prepare for the removal as follows:



Please observe the safety information in chapter ["Important notes", Page 12](#).
Remove the power plug from the mains outlet !

- ▶ Switch the device off.



The device must not be in energy-saving mode !

- ▶ Close the LCD screen.
- ▶ Remove all the cables from the device.
- ▶ Turn the device over and place it on a stable, flat and clean surface. If necessary, lay an anti-slip cloth on this surface to prevent the device from being scratched.
- ▶ Remove the battery (see ["Removing the battery", Page 31](#)).

Installing and removing memory expansion

If you are asked by the Hotline/Service Desk to remove and install the memory expansion yourself, proceed as follows:



Please observe the safety information in chapter ["Important notes", Page 12](#).

When installing/removing memory modules, the battery must be removed from the notebook and the notebook must not be connected to the power supply, see ["Preparing to remove components", Page 48](#).

Only use memory expansion modules that have been approved for your notebook (see ["Technical data", Page 65](#)).

Never use force when installing or removing a memory extension.

Make sure that foreign objects do not fall into the memory extension compartment.

You must open the service compartment to remove or install a memory module. On some devices, opening the compartment may expose other components. These components should be removed and replaced only by authorised specialists. Therefore, be sure to observe the following:



Individual components can become very hot during operation. Therefore, we recommend that you wait one hour after switching off the notebook before removing or installing memory modules. Otherwise, there is a risk of suffering burns!

As some components are exposed that are sensitive to static electricity, please take note of chapter ["Notes on installing and removing boards and components", Page 47](#).

Removing the cover

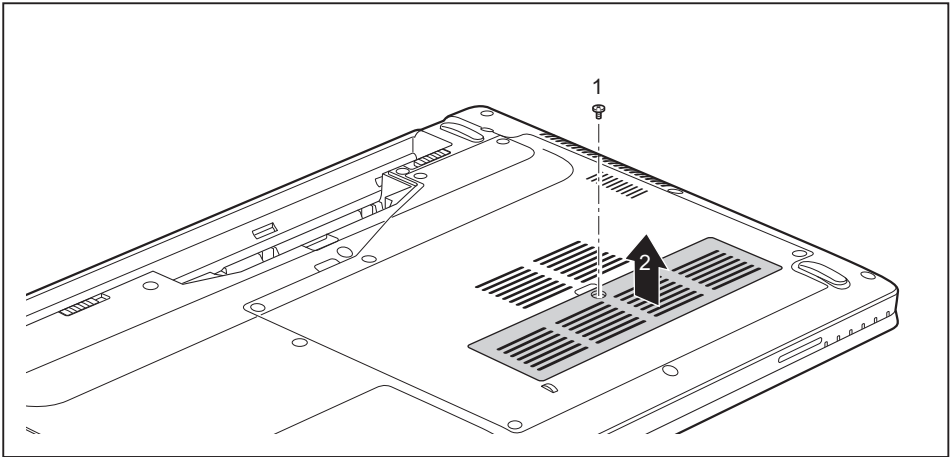

- ▶ Remove the screw (1).



Keep the screw in a safe place. If you are removing several components at the same time, store the screws for the individual components separately from each other.

When installing the cover, you must use the correct screws.

If you install the wrong screws, components may be damaged.

- ▶ Lift the cover off the notebook (2).

Removing memory modules

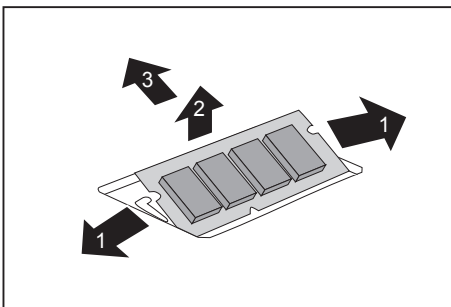

- ▶ Carefully push the two mounting clips outwards (1).
- ↳ The memory module snaps upwards (2).
- ▶ Pull the memory module out of its slot in the direction of the arrow (3).

Installing a memory module

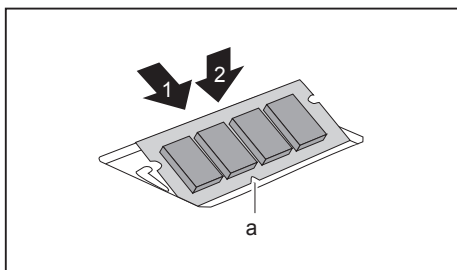

- ▶ Insert the memory module with the contacts and the recess (a) facing the slot (1).
- ▶ Carefully push the memory module downwards until you feel it click into place (2).

Securing the cover

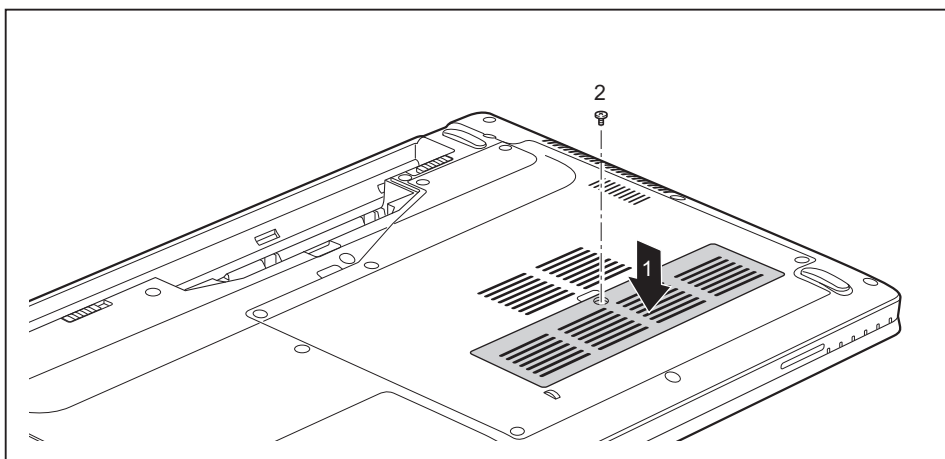

- ▶ Place the cover into its installation position in the direction of the arrow (1).



When installing the cover, you must use the correct screws.
If you install the wrong screws, components may be damaged.

- ▶ Secure the cover using the screw (2).

Removing and installing the hard disk

Removing a cover

- ▶ Remove the battery (see Chapter ["Removing the battery", Page 31](#)).

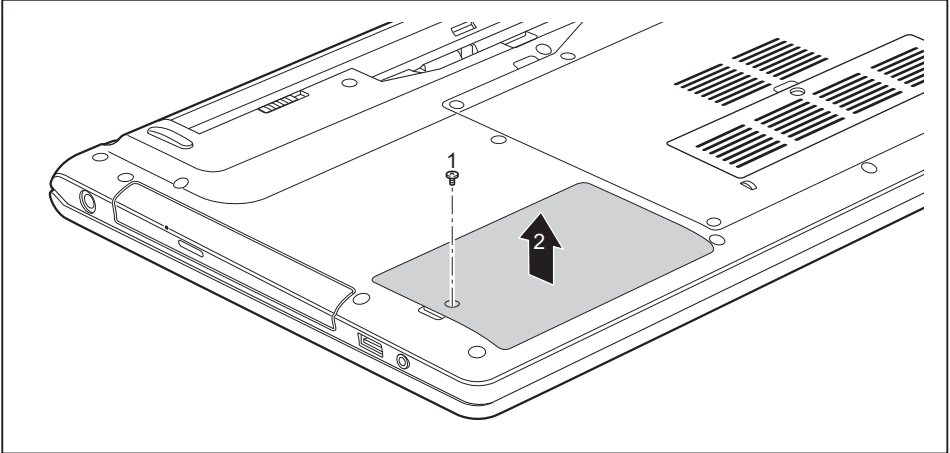

- ▶ Remove the screw (1).



Keep the screws in a safe place. If you are removing more than one component at the same time, store the screws for the individual components separately from each other. If you install the wrong screws, components may be damaged.

When the cover is installed, the correct screws must be used.

- ▶ Lift the cover off the notebook (2).

Removing a hard disk

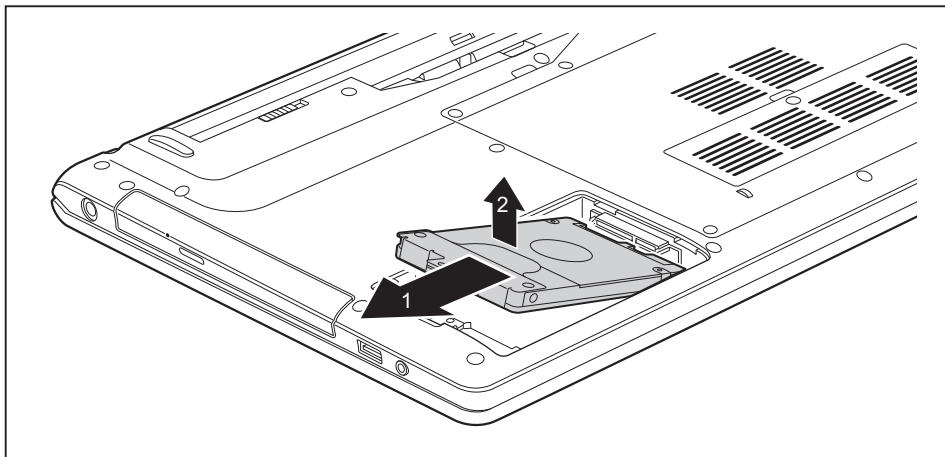

- ▶ To release the hard disk from the contacts, pull the hard disk in the direction of the arrow (1) using the pull-out aid.
- ▶ Remove the hard disk from the hard disk compartment (2).

Installing a hard disk



If you are installing more than one component at the same time, keep the screws for the individual components separately from each other and make sure that you use the correct screws. If you install the wrong screws, components may be damaged.

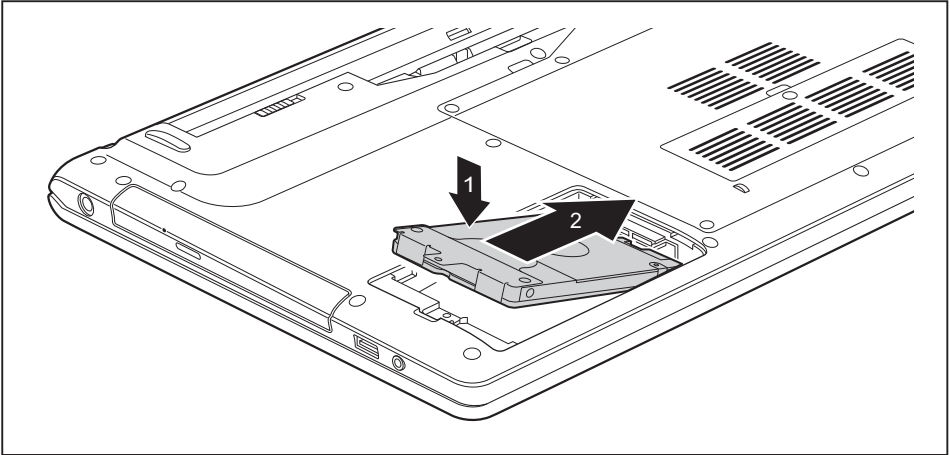

- ▶ Place the hard disk into the hard disk compartment (1).
- ▶ Use the pull-out aid to slide the hard disk in the direction of the arrow (2) until it is heard to engage.

Attaching the cover

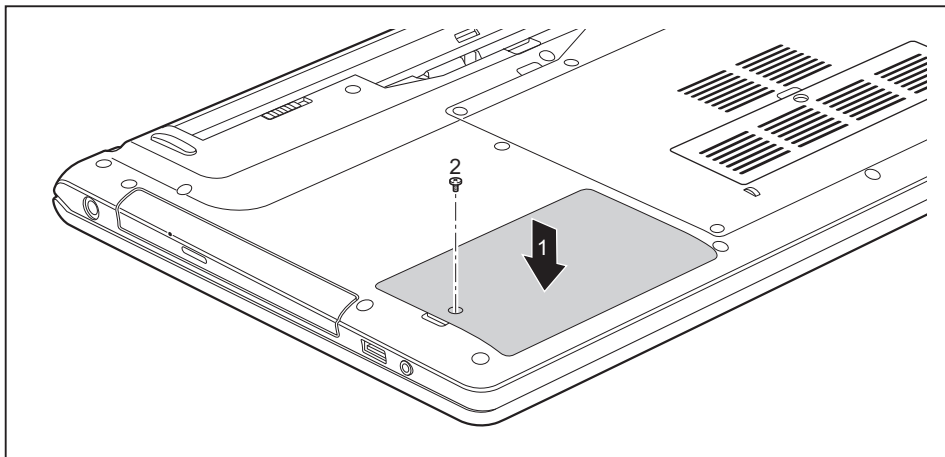

- ▶ Place the cover into position, following the direction of the arrow (1).



When installing the cover, you must use the correct screws.
If you install the wrong screws, components may be damaged.

- ▶ Fasten the cover in place with the screw (2).

Finishing component removal

After you have removed or changed the system components as you required, please prepare your device for operation again as follows:

- ▶ Install the battery again (see ["Inserting battery", Page 32](#)).
- ▶ Turn the notebook the right way up again and place it on a flat surface.
- ▶ Reconnect the cables that you disconnected before.

Settings in BIOS Setup Utility

The *BIOS Setup Utility* allows you to set the system functions and the hardware configuration for the notebook.

When it is delivered, the notebook is set to factory default settings. You can change these settings in *BIOS Setup Utility*. Any changes you make take effect as soon as you save and exit the *BIOS Setup Utility*.

The *BIOS Setup Utility* program contains the following menus:

<i>About</i>	Displays information relating to the BIOS, processor and notebook
<i>System</i>	Advanced system settings
<i>Advanced</i>	Configuration of various hardware components, such as mouse, keyboard, processor
<i>Security</i>	Password settings and security functions
<i>Boot</i>	Configuration of the start-up sequence
<i>Exit</i>	Exits the <i>BIOS Setup Utility</i>

Starting the BIOS Setup Utility

- ▶ Reboot the device (switch off/on or reboot the operating system).
- ↳ Depending on the *BIOS Setup Utility* setting for *Fast Boot* the following message may appear on the screen at start-up:
<F2> BIOS Setup <F12> Boot Menu
- ▶ Press the function key **F2**.
- ▶ If a password has been assigned, enter the password and press the Enter key.



If you have forgotten the password, contact your system administrator or contact our customer service centre.

The *BIOS Setup Utility* starts.

Operating BIOS Setup Utility



Press the **[F1]** key to display help on the operation of the *BIOS Setup Utility*. The description of the individual settings is shown in the right-hand window of the *BIOS Setup Utility*.

With the **[F9]** key you can load the default settings of the *BIOS Setup Utility*.

- ▶ Use the cursor keys **[←]** or **[→]** to select the menu you wish to access to make changes.
- ↳ The menu is displayed on the screen.
- ▶ Select the option you want to change with the cursor keys **[↑]** or **[↓]**.
- ▶ Press the Enter key.
- ▶ Press the **[ESC]** key to exit the selected menu.
- ▶ For future reference, make a note of the changes you have made (for example, in this manual).

Exiting BIOS Setup Utility

You need to select the desired option in the *Exit* menu and activate it by pressing the Enter key:

Exit Saving Changes - save changes and exit BIOS Setup Utility

- ▶ To save the current menu settings and exit the *BIOS Setup Utility*, select *Exit Saving Changes* and *Yes*.
- ↳ The notebook is rebooted and the new settings come into effect.

Exit Discarding Changes – Discard changes and exit BIOS Setup Utility

- ▶ To discard the changes, select *Exit Discarding Changes* and *Yes*.
- ↳ The settings in place when *BIOS Setup Utility* was called remain effective. *BIOS Setup Utility* is terminated and the notebook is rebooted.

Load Setup Defaults – Copy Standard Entries

- ▶ To copy the standard entries for all menus of the *BIOS Setup Utility*, choose *Load Setup Defaults* and *Yes*.

Discard Changes – Discard changes without exiting the BIOS Setup Utility

- ▶ To discard the changes you have made, select *Discard Changes* and *Yes*.
- ↳ The settings in place when *BIOS Setup Utility* was called remain effective. You can now make additional settings in the *BIOS Setup Utility*.
- ▶ If you want to exit *BIOS Setup Utility* with these settings, select *Exit Saving Changes* and *Yes*.

Save Changes - save changes without exiting the BIOS Setup Utility

- ▶ To save the changes, select *Save Changes* and *Yes*.
- ↳ The changes are saved. You can now make additional settings in the BIOS Setup Utility.
- ▶ If you want to exit BIOS Setup Utility with these settings, choose *Exit Saving Changes* and *Yes*.

Save Changes and Power Off

- ▶ To save the changes and switch off your device, select *Save Changes and Power Off* and *Yes*.
- ↳ The changes are saved. Your device is shut down.

Troubleshooting and tips



Follow the safety notes in the "Safety/Regulations" manual when connecting or disconnecting cables.

If a fault occurs, try to correct it as described. If you fail to correct the problem, proceed as follows:

- ▶ Make a note of the steps and the circumstances that led to the fault. Also make a note of any error messages displayed.
- ▶ Switch the notebook off.
- ▶ Please contact the Hotline/Service Desk.



You can find the telephone numbers in the service desk list. Please have the following information ready when you call:

- The model name and serial number of the notebook. The serial number is located on a sticker on the underside of the notebook.
- Notes of any messages that appear on the screen and information on acoustic signals.
- Any changes you have made to the hardware or software since receiving the notebook.
- Any changes you have made to the *BIOS Setup* settings since receiving the notebook.
- Your system configuration and all peripheral devices connected to your system.
- Your sales contract.



Our notebooks have been designed primarily with mobile applications in mind. This means that considerable effort has been made to optimise components and equipment in terms of weight, space and energy requirements. Depending on the particular configuration you have purchased, it is possible that functionality may be slightly reduced compared to a desktop PC if you are running processor-intensive gaming software, e.g. games with intensive 3D graphics. Updating your hardware with drivers which have not been approved by Fujitsu Technology Solutions may result in performance losses, data losses or malfunction of the equipment. A list of approved drivers and current BIOS versions can be downloaded from: ["http://support.ts.fujitsu.com/Download/Index.asp"](http://support.ts.fujitsu.com/Download/Index.asp)

Help if problems occur

Should you encounter a problem with your computer that you cannot resolve yourself:

- ▶ Note the ID number of your device. The ID number is found on the type rating plate on the back or underside of the casing.
- ▶ For further clarification of the problem, contact the Service Desk for your country (see the Service Desk list or visit the Internet at ["http://support.ts.fujitsu.com/contact/servicedesk/ServiceDeskNumber_Int.asp"](http://support.ts.fujitsu.com/contact/servicedesk/ServiceDeskNumber_Int.asp)). When you do this, please have ready the ID number and serial number of your system.

Restoring the hard disk contents under Windows

You can use the "Windows Recovery CD" (optionally available) and the "Drivers & Utilities CD/DVD" to reinstall the operating system.

The instructions are provided on the case of the Recovery CD.



During the reinstall process your personal files and any installed programs will be deleted. We advise you to backup your files to an external hard drive, or CD / DVD disk before you start.

- ▶ Switch the notebook on.
 - ↳ Depending on the *BIOS Setup Utility* setting for *Fast Boot* the following message may appear on the screen at start-up:
`<ESC>Diagnostic screen <F12>Boot Menu <F2>BIOS Setup`
 - ▶ When this message appears, press the function key **F12**.
 - ▶ Insert the "Windows Recovery CD" into the optical drive.
 - ▶ Select *CD-ROM* and press the Enter key.
 - ▶ Follow the instructions on the screen.
- After the installation you must install all the drivers again. Some installed hardware components will not be correctly supported until this has been done.
- ▶ Insert the "Drivers & Utilities" CD/DVD into the optical drive. The CD starts automatically.
 - ▶ Click on the *Desk Update* button.
 - ▶ Select *Automatic driver installation (Express)* and click on *Start installation*.
 - ▶ Follow the instructions on the screen.
 - ▶ Restart your notebook when the driver installation is completed.

The notebook's date or time is incorrect

Cause	Troubleshooting
Time and date are incorrect.	▶ With the <i>BIOS-Setup-Utility</i> , you can set the date and time in the <i>main</i> menu.
If the time and date are still set incorrectly after switching on the notebook.	▶ Please contact your sales outlet or our Hotline/Service Desk.

The notebook's LCD screen remains blank

Cause	Troubleshooting
Monitor is switched off.	▶ Press a key or touch the touchpad.
External monitor or television set connected.	▶ Press the key combination to switch the screen output, see "Key combinations" , Page 24 .

The LCD screen is difficult to read

Cause	Troubleshooting
Reflected glare	<ul style="list-style-type: none"> ▶ Turn the notebook or alter the tilt of the LCD screen. ▶ Increase the brightness of the screen.

The external monitor remains blank

Cause	Troubleshooting
Monitor is switched off.	▶ Switch the external monitor on.
Power saving has been activated (monitor is blank).	▶ Press any key to continue.
Brightness is set to dark.	▶ Adjust the brightness of the monitor.
Screen output is set to the notebook's LCD screen	▶ Press the key combination to switch the screen output, see " Key combinations ", Page 24 .
The external monitor's power cable or data cable is not connected properly.	<ul style="list-style-type: none"> ▶ Switch off the external monitor and the notebook. ▶ Check whether the power cable is plugged properly into the external monitor and into the power socket. ▶ Check whether the data cable is properly connected to the notebook and the external monitor (if it is plugged in with a connector). ▶ Switch on the external monitor and the notebook.

The external monitor is blank or the image is unstable

Cause	Troubleshooting
The wrong external monitor has been selected or the wrong screen resolution has been set for the application program.	<ul style="list-style-type: none"> ▶ Terminate the application program in Windows by pressing <code>[Alt] + [F4]</code>. If the fault persists after closing the program, use the key combination for switching the screen output (see "Key combinations", Page 24) to switch over to the notebook's LCD screen. Change the following setting: ▶ Set the screen resolution: Set the screen resolution as described in the documentation for your operating system. ▶ Select monitor: Select monitor 1 or 2 as described in the documentation for your operating system.

The notebook cannot be started

Cause	Troubleshooting
The battery is not installed correctly.	<ul style="list-style-type: none"> ▶ Check whether the battery is installed correctly in its compartment. ▶ Switch the notebook on.
The battery is dead.	<ul style="list-style-type: none"> ▶ Charge the battery. <p>or</p> <ul style="list-style-type: none"> ▶ Insert a charged battery. <p>or</p> <ul style="list-style-type: none"> ▶ Connect the mains adapter to the notebook.
The mains adapter is not connected correctly.	<ul style="list-style-type: none"> ▶ Check whether the mains adapter is connected correctly to the notebook. ▶ Switch the notebook on.

The notebook stops working

Cause	Troubleshooting
Notebook is in energy saving mode.	<ul style="list-style-type: none"> ▶ Leave energy saving mode.
An application programme has caused the malfunction.	<ul style="list-style-type: none"> ▶ Close the application program or restart the notebook (by restarting the operating system or switching the device off and back on again).
The battery is dead.	<ul style="list-style-type: none"> ▶ Charge the battery. <p>or</p> <ul style="list-style-type: none"> ▶ Insert a charged battery. <p>or</p> <ul style="list-style-type: none"> ▶ Connect the mains adapter to the notebook.

The printer does not print

Cause	Troubleshooting
The printer is not switched on.	<ul style="list-style-type: none"> ▶ Make sure that the printer is switched on and ready for operation (refer to the documentation supplied with the printer).
The printer is not connected correctly.	<ul style="list-style-type: none"> ▶ Check that the data cable connecting the notebook to the printer is properly connected.
The printer driver is faulty or not correctly installed, or it is the wrong printer driver.	<ul style="list-style-type: none"> ▶ Check that the data cable connecting the notebook to the printer is properly connected. ▶ Check whether the correct printer driver is loaded (refer to the printer documentation).

The radio connection to a network does not work

Cause	Troubleshooting
The wireless component is disabled.	<ul style="list-style-type: none"> ▶ Switch the radio component on (see "Switching the wireless components on and off", Page 37).
The wireless component is enabled. Despite this, the wireless connection to a network does not work.	<ul style="list-style-type: none"> ▶ Check whether the radio connection is switched on via the software. ▶ Further information on using the radio component can be found in the help files.

Acoustic warnings

Cause	Troubleshooting
<p>A beep sounds every few seconds.</p> <p>The battery is almost flat.</p>	<ul style="list-style-type: none"> ▶ Charge the battery.

Error messages on the screen

This section describes the error messages generated by the BIOS Setup. Error messages displayed by the operating system or programmes are described in the relevant documentation.



If the error message appears repeatedly, despite troubleshooting measures, please contact the place of purchase or our customer service centre.

Error message/cause	Resolution
<p><i>CMOS battery bad</i></p> <p>If the error message occurs repeatedly, the buffer battery in the notebook is flat.</p>	<ul style="list-style-type: none"> ▶ Contact your sales outlet or our customer service centre.
<p><i>System CMOS checksum bad - default configuration used</i></p> <p>The system configuration information is incorrect.</p>	<ul style="list-style-type: none"> ▶ Switch the notebook off. ▶ Switch the notebook on. ▶ Press the function key [F2] to access the <i>BIOS Setup</i>. ▶ In the <i>BIOS Setup</i>, select the <i>Exit</i> menu. ▶ Select the entry <i>Load Setup Defaults</i>. ▶ Select <i>OK</i> and press the Enter key.
<p><i>Extended memory failed at offset: xxxx Failing Bits: zzzz zzzz</i></p> <p>When testing the extended memory an error has resulted at the address xxxx.</p>	<ul style="list-style-type: none"> ▶ Check whether the additional memory module has been inserted correctly.
<p><i>Failure Fixed Disk n</i></p> <p>The settings of the hard disk drive are incorrect.</p>	<ul style="list-style-type: none"> ▶ Start the <i>BIOS Setup (Primary Master submenu)</i> and select the correct settings.
<p><i>Keyboard controller error</i></p>	<ul style="list-style-type: none"> ▶ Switch the notebook off with the ON/OFF switch. ▶ Wait 3 - 5 seconds and switch on the notebook again.
<p><i>Keyboard error</i></p>	<p>If you are using an external keyboard:</p> <ul style="list-style-type: none"> ▶ Check the connection and reboot the notebook.
<p><i>nn Stuck key</i></p>	<ul style="list-style-type: none"> ▶ Make sure that no key is pressed.
<p><i>Operating system not found</i></p>	<ul style="list-style-type: none"> ▶ Check in the <i>BIOS Setup</i> whether your hard disk has been set correctly. ▶ Make sure that the operating system is installed on the corresponding drive.
<p><i>Press <F1> to resume, <F2> to SETUP</i></p> <p>This error message appears if an error occurs during the self-test before starting the operating system.</p>	<ul style="list-style-type: none"> ▶ Press the [F1] function key to start the operating system. ▶ Press the function key [F2] to access the <i>BIOS Setup</i>.

Error message/cause	Resolution
<i>Previous boot incomplete - Default configuration used</i> Due to an error during the previous system boot, default values were used for certain settings. Check the settings in the BIOS Setup.	▶ Press the <input type="text" value="F1"/> function key when prompted to do so.
<i>Real time clock error</i>	▶ Contact your sales outlet or our customer service centre.
<i>nnnnK Shadow RAM failed at offset: xxxx Failing Bits: zzzz</i>	▶ Contact your sales outlet or our customer service centre.
<i>System battery is dead - Replace and run SETUP</i>	▶ Contact your sales outlet or our customer service centre.
<i>System cache error - Cache disabled</i>	▶ Contact your sales outlet or our customer service centre.
<i>System timer error</i>	▶ Contact your sales outlet or our customer service centre.

Technical data

LIFEBOOK

Ambient conditions	
Temperature:	
Operation	5 °C 35 °C / 41 °F 95 °F
Transportation	-15 °C 60 °C / 5 °F 140 °F
Dimensions	
Width x Depth x Height	378 mm x 256 mm x 30.9 mm / 14.88 Inch x 10.08 Inch x 1.22 Inch
Weight (including 6-cell rechargeable battery)	approximately 2.4 kg / 5.29 lbs

Rechargeable battery



You can find information on the batteries used in your device on the Internet at ["http://www.fujitsu.com/fts/support/"](http://www.fujitsu.com/fts/support/).

	6-cell rechargeable battery
Rated voltage	10.8 V
Rated capacity	4500 mAh (49 Wh)

Mains adapter (90W)

Primary

Rated voltage	100 V to 240 V (automatic)
Rated frequency	50 Hz to 60 Hz (automatic)

Secondary

Rated voltage	19 V
Max. rated current	4.74 A

An additional mains adapter or power cable can be ordered at any time.

Mains adapter, 65 W

Primary

Rated voltage	100 V to 240 V (automatic)
Rated frequency	50 Hz to 60 Hz (automatic)

Secondary (device-dependent)

Rated voltage	19 V
Max. rated current	3.42 A

An additional mains adapter or power cable can be ordered at any time.

Manufacturer's notes

Disposal and recycling

You can find information on this subject on your notebook or on our website (["http://www.fujitsu.com/fts/about/fts/environment-care/"](http://www.fujitsu.com/fts/about/fts/environment-care/)).

Declarations of Conformity

The "Declarations of Conformity" for the device can be found on the Internet at: ["http://globasp.ts.fujitsu.com/sites/certificates/default.aspx"](http://globasp.ts.fujitsu.com/sites/certificates/default.aspx).

Fujitsu Technology Solutions hereby declares that your device is in compliance with the essential requirements and other relevant provisions of Directive 1999/5/EC.

CE marking

CE marking for devices with radio component

The shipped version of this device complies with the requirements of Directive 2009/125/EC "Ecodesign directive", Directive 2011/65/EU "RoHS Directive" and R&TTE directive 199/5/EC of the European Parliament and Commission of 9th March 1999 governing Radio and Telecommunications Equipment and mutual recognition of conformity.

CE nnnn (!) ; nnnn: For digits and exclamation mark (!), see label on the product.

You can find more information and declarations of conformity on the Internet at: ["http://globasp.ts.fujitsu.com/sites/certificates"](http://globasp.ts.fujitsu.com/sites/certificates).

This equipment can be used in the following countries:

Belgium	Bulgaria	Denmark	Germany
Estonia	Finland	France	Greece
UK	Ireland	Iceland	Italy
Latvia	Liechtenstein	Lithuania	Luxembourg
Malta	The Netherlands	Norway	Austria
Poland	Portugal	Romania	Sweden
Switzerland	Slovakia	Slovenia	Spain
Czech Republic	Hungary	Cyprus	Croatia
Turkey			

Contact the corresponding government office in the respective country for current information on possible operating restrictions. If your country is not included in the list, then please contact the corresponding supervisory authority as to whether the use of this product is permitted in your country.

Other certification markings

Any other certification markings are listed in the "Manual Appendix - Additional Certifications" supplement.

If such markings are available, you can find the supplement on the Internet at ["http://support.ts.fujitsu.com/Manuals/"](http://support.ts.fujitsu.com/Manuals/) with the Operating Manual for your device.

Index

A

- Acoustic error messages 62
- Alt + Tab 25
- Anti-theft protection 39
- Audio ports 46

B

- Back tab 25
- Backspace 23
- Bass loudspeaker (subwoofer) 37
- Battery
 - battery life 30
 - caring for and maintaining 30
 - charge level 30, 35
 - charging 30
 - self-discharge 30
 - storage 30
- Battery indicator 20
- Battery status indicator
 - see Battery indicator 20
- Battery status meter 30
- Battery symbol
 - see Battery indicator 20
- BIOS Setup Utility
 - calling 55
 - exiting 57
 - operating 56
 - protecting with password 40
 - settings 55
- Bluetooth
 - Switching the module off 37
 - Switching the module on 37
- Bluetooth, safety notes 12
- Board 47
- Buffer battery, load 59
- Buttons 22

C

- Caps Lock 23
 - indicator 20
- CD/DVD indicator 33
- CD/DVD:
 - manual emergency removal 34
- CE marking 67
- Certification markings 68
- Charging capacity, battery 30
- Cleaning 15
- Components
 - installing / removing 47
- Configuration, BIOS Setup Utility 55

- Connecting audio devices 46
- Connecting headphones 46
- Crystal View display
 - cleaning 15
- Ctrl+Alt+Del 25
- Cursor control keys 23
- Cursor keys 23

D

- Date is incorrect 59
- Declaration of conformity 67
- Device
 - setting up 17
- Drive
 - indicator 20

E

- Emergency removal of data carrier 34
- Energy
 - energy saving 13
- Energy saving 13
- Energy saving functions 25
- Energy saving mode
 - leaving 61
- Enter 23
- Enter key 23
- Error message:
 - on the screen 63
- Error messages on the screen 63
- Errors
 - Acoustic warnings 62
- ESD 47
- Ethernet LAN 38

F

- Fault
 - correction 58
- First-time setup 16
- Fn key 23
- Fn+F10 25
- Fn+F11 25
- Fn+F12 25
- Fn+F3 24
- Fn+F4 24
- Fn+F5 24
- Fn+F6 25
- Fn+F7 25
- Fn+F8 25
- Fn+F9 25

- G**
 - Getting started 16
- H**
 - Handling
 - data carriers 32
 - Hard disk:
 - restoring the contents 59
 - Hardware configuration 55
 - HDMI port 44
- I**
 - Important notes 12
 - Incorrect date/time 59
 - Indicator
 - Caps Lock 20
 - drive 20
 - Num Lock 20
 - Inserting
 - a data carrier 33
- K**
 - Key combinations 24
 - Keyboard 22
 - cleaning 15
- L**
 - LCD screen
 - cleaning 15
 - decrease brightness 25
 - difficult to read 60
 - notes 28
 - reflected glare 60
 - remains blank 59
 - LCD screen is too dark 59
 - Life, battery 30
 - Line feed 23
 - Loudspeakers 37
 - switch off 24
 - switch on 24
- M**
 - Main memory
 - see Adding memory 48
 - Mains adapter
 - connecting 17
 - setting up 17
 - Manual removal of data carrier 34
 - Mechanical backup 39
 - Memory card
 - handling 36
 - inserting 36
 - removing 36
 - Memory expansion
 - installing 50
 - removing 49
 - Memory module
 - important notes 48
 - installing 50
 - removing 49
 - Microphone 37
 - Mobile operation 14
 - Monitor
 - connecting 43
 - drifting display 60
 - remains blank 60
 - Monitor port
 - see VGA connection socket 43
- N**
 - Notebook
 - before you travel 14
 - cannot be started 61
 - cleaning 15
 - stops working 61
 - switching off 21
 - transporting 14
 - using 19
 - Notebook, operation 19
 - Notes 12
 - boards 47
 - cleaning 15
 - disposal / recycling 67
 - energy saving 13
 - LCD screen 28
 - Safety 12
 - transport 14
 - Num Lock
 - indicator 20, 24
 - Numeric keypad 22
 - see Separate numeric keypad 24
- O**
 - Operating system
 - activating system protection 41
 - cancel system protection 41
 - protecting with password 41
 - Operating system, restoring 59
 - Optical drive 32
- P**
 - Packaging 16

- Password
 - changing 41
 - entering 40
 - removing 41
 - Password protection 40
 - Password protection:
 - hard disk 42
 - Power
 - power consumption 35
 - power-management features 35
 - Power indicator 20
 - Preparing for operation 17
 - Printer does not print 62
- R**
- Radio component:
 - safety notes 12
- Rechargeable battery 30
 - see Battery 30
- Removing
 - a data carrier 33
- Removing memory
 - see Adding memory 48
- Return 23
- S**
- Safety notes 12
- Screen
 - no screen display 60
- Screen brightness
 - decrease 25
 - increase 25
- Screen port
 - see VGA connection socket 43
- Security functions 39
- Security Lock 39
- Selecting a location 17
- Self-discharge, battery 30
- Separate numeric keypad 24
- Servicing 47
- Setup
 - see BIOS Setup Utility 55
- Shift 23
- Shift + Tab 25
- Shift key 23
- Slot
 - Memory cards 36
- Standby indicator 20
- Status indicators 19
- Summer time 59
- Supervisor password
 - changing 41
 - entering 40
 - removing 41
- Switching on
 - the notebook 20
- Switching on for the first time 18
- System configuration 55
- System expansion 48
 - see Adding memory 48
- System settings, BIOS Setup Utility 55
- T**
- Tab key 23
- Technical data 65
 - Mains adapter 65–66
 - notebook 65
- The radio connection to a network does
 - not work 62
- Time not correct 59
- Time, daylight savings 59
- Tips 58
- Toggle output screen 25
- Touchpad 24, 26
 - buttons 26
 - cleaning 15
 - dragging items 27
 - executing commands 27
 - moving the pointer 26
 - selecting an item 27
 - switch off 24
- Touchpad buttons 24
- Transport
 - Transport damage 16
- Transportation 14
- Travel, notebook 14
- Troubleshooting 58
- U**
- USB charging function 45
- USB ports 44
- User password
 - changing 41
 - entering 40
 - removing 41
- Using the Kensington Lock Cable 39
- V**
- VGA connection socket 43
- Volume
 - decrease 25
 - increase 25
- Volume control 37

W

Webcam 29

off 25

Windows key 23

Wireless components

switch off 24

switch on 24

Wireless LAN

Switching the module off 37

Switching the module on 37

Wireless LAN:

safety notes 12